

design2machine

btl interface description

Version: 10.6

Build: 10602

Last modified: 10.05.2022

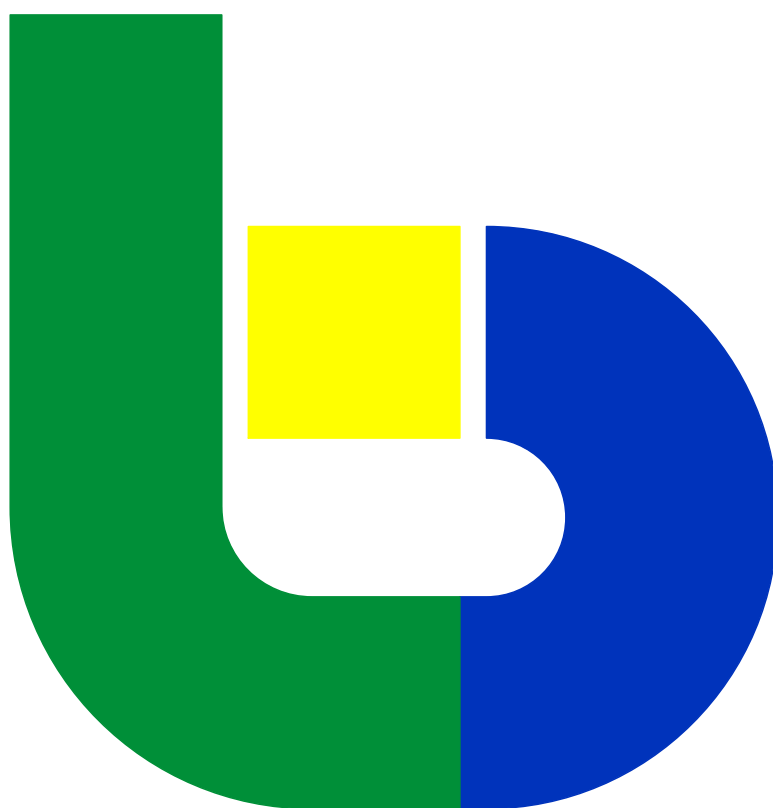

Common Data Interface for Wood Working Machines

The following interface description is designed for the structured representation of the data relevant to the manufacturing process.

It does not contain any machine specific data. This allows the interface to be used as a common data interface.

If there is a need to prepare the data stored in this interface for some special wood working machine or some special control, then these data should be imported by a suitable CAM system and then properly processed.

All dimensional measures are in millimeters [mm], all angular measures in degrees [°] and all Integer-Parameters have the size of 32 bit. Range Integer: -2147483648 to 2147483647

Content	Page
0. Interface Architecture	2
1. History	3
2. Basic Structure of the BTL-File	6
3. Caption	12
4. Example File	15
5. Table of Contents, List of processings	17
6. Description of processings	18
7. Prefabrication	109

0. Interface Architecture

The file described herein is identified by the ".btl" extension. It is encoded in UTF-8 and contains general data related to the Project as well as parameter descriptions of the construction forms to be transferred to the wood working machines.

For more information or questions regarding the btl format, please contact:

www.design2machine.com

info@design2machine.com

1. History version 10.6 build 10602

Date	Modification	Build	Page
14.11.2016	The encoding in BTL Files with BUILD \geq 10602 must be in UTF-8.	10602	-
31.05.2017	Correction in Definition of Referenceplane: Parameter OZ: OZ>0 => Referenceplane is off RS.	10602/10601	13
19.10.2017	3/4-080-X Step Joint: Better presentation of sideview.	10602/10601	93
17.11.2017	3/4-082-X Birdsmouth: New limits for P04 and better presentation.	10602/10601	36, 39
27.02.2018	Description of LAYER: It is the reference side of the ELEMENT	10602	10
27.03.2018	Parameter LAYER only for [COMPOSITE]-parts with Type: LAYER	10602	10
18.04.2018	LAYER: Replaced Modifications from 27.02.2018 and 27.03.2018	10602	10, 133
18.04.2018	3/4-020-X Birdsmouth: P04=-1 (instead of =0): Location of P09/P10 is defined on machineside, like before 04.11.2014	10602	39
29.03.2019	G-250-X Contour: Exact description. Lock-out area for P14=0	10602	129
30.05.2019	G-250-X Contour: Lock-out area for another 4 types available	10602	129
30.05.2019	G-250-X Contour: Meaning of inclination P06 at startpoint	10602	127, 128
24.06.2019	G-250-X Contour: Min/Max and Presetting for P06	10602	128
01.07.2020	3/4-020-X Birdsmouth: P04 for location of P09/P10	10602	35, 36
04.01.2021	G-250-X Contour: Referenceplane only at startpoint respected	10602	12, 13, 130
27.12.2021	G-250-X Free Contour: Deleted unnecessary P15 and Comment	10602	129
28.01.2022	G-250-X: Countersink makes only sense at Free and Mill Contour	10602	128
10.05.2022	Definition of Integer-, Doublevalues	10602	2

History version 10.6 build 10601

Date	Modification	Build	Page
03.11.2014	0-012-X Ridge or Valley Cut: Changed Min/Max for P11 from 0/50000 to +/- 99999	10601	26
04.11.2014	G-017-X Front Slot: Added P04 for limits of the 4 sides of a slot	10601	34
04.11.2014	3/4-030-X Lap Joint: P04 for location of P09/P10	10601	45, 46
04.11.2014	3/4-020-X Birdsmouth: P04 for location of P09/P10	10601	35, 39, 36
22.04.2015	Added company LIGNOCAM	10601	2
05.10.2015	Corrected a literal error: HRS instead of HWS	10601	52, 54
15.12.2015	3/4-030-X Lap Joint: Location for P09/P10	10601	45, 46
29.02.2016	3/4-040-X Drilling: Change limit diameter from 1000 to 50000	10601	67
	Free contour / Nail contour: Remarks to Nail Spacing	10601	129
13.05.2016	Contact and questions	10601	2

History version 10.6 build 10600

Date	Modification	Build	Page
10.09.2012	Additional attributes for a part.	10600	10, 11
11.09.2012	New processing Hip or Valley Rafter Notch 3/4-025-X.	10600	40
11.10.2012	3/4-036-X Chamfer: new Min/Max values for P11.	10600	58
15.10.2012	0/3/4-013-X Saw Cut: new Min/Max values for P12.	10600	28
09.11.2012	3/4-016-X Slot: Correction of the presentation of P12 (length)	10600	29
22.11.2012	G-250-X Contour: Use of P07 and P15.	10600	128
12.12.2012	G-013-X Saw Cut: new Min/Max values for P08.	10600	28
31.01.2013	G-060-X Marking: horizontal line possible and new Min/Max for P06.	10600	84, 86
	Additional attributes for a project, part or processing.	10600	6
29.10.2013	3/4-030-X Half Lap: new default value for P14. 0 instead WRS.	10600	47
03.06.2014	3/4-030-X Half Lap: Additional argument for "not limited". Case "P02+P14 =WRS" is complemented with "or P14 = 0".	10600	45, 46
14.07.2014	New drawings for limits in processings 016, 030, 032 and 039 3/4-030-X Half Lap: add P14 in drawing for P09/P10.	10600	30, 48, 50, 65 48

30.07.2014	3/4-030-X Half Lap and 3/4-020-X Birdsmouth: Better description of the place of angles P09/P10. See P02 and Grooving Depth	10600	35, 36, 45
26.08.2014	G-013-X Saw Cut: new Min/Max values for P07.	10600	28
29.09.2014	1/2-055-X Dovetail Tenon: Changed limits of P12 from 0/1000 to +/- 1000.	10600	70

History versions 10.4, 10.5

Date	Modification	Build	Page
17.07.2009	4-037-X Block House Half Lap: Add arc	10400	39
	G-136-X Tyrolean Dovetail: Added this new processing	10400	95
	G-106-X Profile Head: Added this new processing	10400	89
20.07.2009	The new parameter UID, instead of the old parameter P09, in a rawpart refers to the part.	10400	7
	UID and transformation	10400	7
16.10.2009	A new parameter P04 for rounding at dovetail tenon 1,2-055-X	10400	77
	A new parameter P04 for rounding at dovetail mortise 3,4-055-X	10400	80
	A new parameter P04 for rounding at dovetail mortise front 3,4-056-X	10400	82
	A name for a processkey is possible	10400	11
	A name for a processkey, which points to a subpart, is possible	10400	7
	Definition of PROCESSPARAMETERS: Added a new definition	10400	11
	3,4-016-X Slot: Added P04 for limits of the 4 sides of a slot	10400	31
25.11.2009	Limit of P02 at Pocket 4-039-X changed from 0/50000 to +/- 50000	10400	64
06.02.2010	3,4-060-X Marking: 3 new positions for the text. Bit 12,13,14	10400	84
20.04.2010	G-013-X Saw Cut: Min/Max for P06 is +/- 180° instead of 0°/180°.	10400	27
20.04.2010	G-039-X Pocket: Min/Max for P02 is +/- 50000 instead of 0/WRS.	10400	64
22.04.2010	G-250-X Contour: A remark for the processing attributes.	10400	127
11.06.2010	Dovetail: Limits of margins P14/P15 are +/-1000 instead of 0/1000.	10400	78
14.06.2010	Profile Head 3/4-103-X: Changed description of P15 in the drawing. The description in the table was correct.	10400	104
31.08.2010	G-136-X Tyrolean Dovetail: New description for inclination P09.	10400	115
31.08.2010	New Identification Index EDITION for prefabrication.	10400	6
31.08.2010	New part type COMPOSITE for prefabrication.	10400	132
31.08.2010	G-250-X Contour: New paramaters P13, P14, P15 for walls.	10400	127
28.09.2010	G-136-X Tyrolean Dovetail: New description for P01 and P11.	10400	114
30.09.2010	G-106-X Profile Head: Correction at P12, P13 and P14.	10400	108
25.11.2010	G-060-X Marking: Limit for P04 is 0/32767. See also modifications at 06.02.2010	10400	85
01.12.2010	GUID: Globally unique Identifier for the projects.	10400	6
07.02.2011	G-106-X Profile Head: New drawing for the contourlines.	10400	108
04.04.2011	G-010-X Longitudinal Cut: Angles P13 and P14 in face.	10500	20
04.04.2011	G-012-X Ridge or Valley Cut: Angles P13 - P16 in faces.	10500	24
05.04.2011	Outline: Associated contour and contour with inclination.	10500	9
05.04.2011	3/4-030-X Half Lap: New definition of P04 for limits.	10500	47
05.04.2011	Dovetail tenon and mortise: Additional definition of P12 (diameter).	10500	77, 79
13.04.2011	New processing: 4-061-X Text	10500	86
13.04.2011	New attributes for a part: GRAINDIRECTION and REFERENCESIDE.	10500	10
23.06.2011	Subpart refers to the coordinate-system of the superior-part	10500	14
01.09.2011	New parameter RANGE in section [GENERAL]	10500	6
01.09.2011	G-250-X Contour: Limits at the start/end at a saw contour.	10500	127
01.09.2011	APERTURES in an OUTLINE	10500	10
01.09.2011	New processing SPHERE 3/4-107-X	10500	110
18.10.2011	G-016-X Slot: new definition for limits of edges.	10500	31
25.10.2011	G-060-X Marking: New Min/Max for P04.	10500	85
26.10.2011	G-250-X Contour: Distance between start- and endpoint can be 0.	10500	126
10.11.2011	G-060-X Marking: New Min/Max for P04.	10500	85
09.01.2012	3/4-030-X Half Lap: Influence P09/P10 on side-faces.	10500	44
23.04.2012	Contour: Additional description for associated contour	10500	128
23.04.2012	Lock-out area: Better description for P14.	10500	128
06.07.2012	G-010-X and G-012-X: New definition of P04 for limits.	10500	21, 25

History versions 10.0, 10.1, 10.2 10.3

Date	Modification	Build	Page	
24.10.2006	Description of P03 for Lap Joint.	10000	44	
	Description of P03 for Saw Cut.	10000	26	
	Description of P08 - P15 for Block House Half Lap.	10000	58	
	P07 for Step Joint and Step Joint Notch can be more than 90	10000	92, 94	
05.12.2006	Free Contour added. 0/3/4-250-X	10001	127	
05.12.2006	Referenceplane	10001	7, 11	
13.12.2006	Correction of Description of P14: "P14" instead of "P13"	10001	46	
13.12.2006	Description of P04 for Notch/Rabbet	10001	48	
06.04.2007	Added quality for project, part and construction form	10100	6, 8, 11	
	Added rawpart	10100	7	
	Added camber	10100	9	
	Description of the referenceplane in a PROCESSING	10100	12	
	Recess: complete / manual processing	10100	6	
	Priority	10100	11	
	Added colour for part	10100	8	
	Added processing HOUSE	10100	73	
	Added processing HOUSE MORTISE	10100	75	
	Added rounding to tenon	10100	67	
23.04.2007	Added rounding to mortise	10100	69	
	Added chamfer to tenon	10100	67	
	Added processing VARIANT	10100	130	
	Added OUTLINE to the part	10100	9	
	Added COMMENT to the processing	10100	11	
	02.07.2007	Changed Typ A at Step Joint 1/2-080-X	10100	92
	The Pocket 4-039-X is only defined for group 4.	10100	63	
	Alignment of the text at Marking/Labeling 3/4-060-X.	10100	83	
	The Profile head cambered is defined with a cubic polynom.	10100	104	
	Defined the position of the opposite lap at Block house half lap 4-037-X	10100	58	
10.07.2007	Definition of the radius at the tenon with rounding, P04=3	10100	67	
12.09.2007	New Limits of angle P06 drilling: 0/360	10100	65	
20.10.2007	The meaning of STOREY and ANNOTATION was corrected	10100	8	
01.11.2007	Added Triangle Cut	10200	112	
	Added Dovetail	10200	123	
13.11.2007	Added RECESS to project and processing	10200	6, 11	
	Added rafter nail to Birds Mouth	10200	34	
	Specify the angle P10 at Lap Joint	10200	44	
25.11.2007	Description for P04="automatic" at Tenon 1/2-050-X	10200	67	
10.12.2007	New presentation of the drilling parameters	10200	65	
24.01.2008	Contour: Depth only relevant at startpoint	10200	126	
31.01.2008	Depth at Longitudinal Cut 0/3/4-010-X	10200	20	
21.04.2008	Birds Mouth 3/4-020-X: P14/P15 are orthogonal on face.	10200	34	
07.05.2008	Mortise 3/4-050-X: Added P16 in the parameter list.	10200	69	
30.05.2008	Block House Front: Limit of P11, P12, P13.	10200	61	
19.12.2008	Definition of PROCESSINGQUALITY and RECESS.	10300	6, 11	
	PROCESS: YES or NO in all processings possible.	10300	11	
	Block House Half Lap: Drillhole for drop rod.	10300	58	
	Free Contour 0/3/4-250-X: Definition of Inclination P06.	10300	126	
	New attributes for a part: STOREYTYPE, ELEMENTNUMBER, LAYER and MODULENUMBER.	10300	10	
	Additional description for OUTLINE.	10300	9	
	20.12.2008	Corrected the names of the coordinate system.	10300	11, 13
	26.12.2008	Additional description for Slot.	10300	28
		Additional description for Marking / Labeling	10300	83
	28.01.2009	New description for P11 for Longitudinal Cut 0/3/4-010-X	10300	20
Additional description for Slot.		10300	28	
24.02.2009	New presentation of the Step Joint Notch parameters	10300	94	
13.05.2009	Description P03 for Drilling: P03 <> 0 instead of P03 > 0	10300	65	
14.05.2009	Contour: New description for a contour with an associating contour	10300	128	

2. Basic Structure of the btl-File

General: IDENTIFICATION INDEX : Values

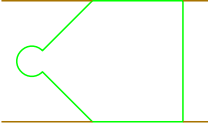
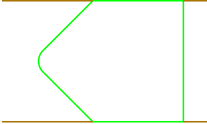
Identification Index	Datotyp	Meaning
VERSION: BUILD: EDITION:	BTL V10.6 (String) 10601 (String) STANDARD or PREFABRICATION	Version number Build number If this attribute is set to PREFABRICATION, the file includes extensions for the construction of prefabricated houses. For more information, see chapter 7.0. If this parameter is not set, its value is assumed to be standard.
[GENERAL]		
PROJECTNUMBER: PROJECTNAME: PROJECTPART: PROJECTGUID:	String max.256 characters String max.256 characters String max.256 characters String 38 characters	Project number Project name Project part Globally unique Identifier If this parameter is set, it is possible to define parts for the same project in several BTL-files. The UIDs of the transformations must be unique. A UID of a transformation may appear only once in all BTL-files for this project. Example: {936DA01F-9ABD-4D9D-80C7-02AF85C822A8}
LISTNAME: CUSTOMER: ARCHITECT: EDITOR: DELIVERYDATE: EXPORTDATE: EXPORTTIME: EXPORTRELEASE: LANGUAGE: RANGE:	String max.256 characters String max.256 characters String max.256 characters String max.256 characters String max.256 characters String max.256 characters String max.256 characters String max.256 characters String max.256 characters STANDARD or EXTENDED	Listname Customer Architect Editor name Delivery date Export date Export time Export release Language Numbers of digits for parameter values. If RANGE is not set, its value is assumed to be STANDARD. STANDARD: Parameter type = String 8 characters EXTENDED: Parameter type = String 12 characters Number of decimals for all values with datatype "Parameter type". See 2. Caption / 8. SCALEUNIT
SCALEUNIT:	Integer	Describes the quality of the project. If this parameter is not set, its value is assumed to be AUTOMATIC.
PROCESSINGQUALITY:	AUTOMATIC, VISIBLE or FAST	Describes the quality of the project. If this parameter is not set, its value is assumed to be AUTOMATIC.
COMPUTERNAME: USER: SOURCEFILE: EXPORTFILE: RECESS:	String max.256 characters String max.256 characters String max.256 characters String max.256 characters AUTOMATIC or MANUAL	Computername User name Path and name of the CAD-File Path and name of the BTL-File If this parameter is not set, its value is assumed to be AUTOMATIC.
		<p>complete RECESS: AUTOMATIC</p>  <p>additional manual work RECESS: MANUAL</p> 

Identification Index	Datotyp	Meaning
USERATTRIBUTE:	String max.256 characters : String max.256 characters	First string: attribute name, second: attribute value. This line may appear several times. Example: USERATTRIBUTE: "Price per rm": "11,43 €"
COMMENT:	String max.256 characters	Comment. This line may appear several times.

Loop over the rawparts
[RAWPART]

The rawpart has the same parameters as a part.
A rawpart can contain several parts. Each part can be defined with the processkey 0-300-0.
The processings of the part are declared in the part-definition. A rawpart can have own processings.
In the BTL-File first the rawparts are declared, then the parts.

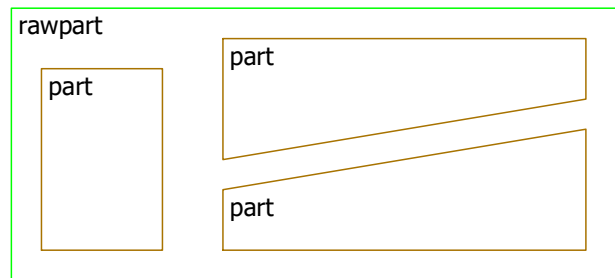

Loop over the processings for rawpart

PROCESSKEY:	0-300-0 DES	With this key a part is set to the rawpart. Subpart refers to the coordinate-system of the rawpart. DES Designation, String max. 256 characters, optional
REFERENCEPLANE:	OX: Parameter type OY: Parameter type OZ: Parameter type XX: Parameter type XY: Parameter type XZ: Parameter type YX: Parameter type YY: Parameter type YZ: Parameter type	Coordinate triple origin of the part-coordinate-system Direction vector of the local x axis Direction vector of the local y axis
PROCESSPARAMETERS:	UID: Integer	UID of the transformation of the part

End of loop over the processings for rawpart

End of loop over the rawparts

Identification Index	Datatypes	Meaning
<i>Loop over the parts</i> [PART]		
SINGLEMEMBERNUMBER: ASSEMBLYNUMBER: ORDERNUMBER: DESIGNATION: ANNOTATION: STOREY: GROUP: PACKAGE: MATERIAL: TIMBERGRADE: QUALITYGRADE: COUNT: LENGTH: HEIGHT: WIDTH: COLOUR:	Integer String max.256 characters Integer String max.256 characters String max.256 characters String max.256 characters String max.256 characters String max.256 characters String max.256 characters String max.256 characters String max.256 characters Integer Parameter type Parameter type Parameter type R: Integer G: Integer B: Integer A: Integer Parameter type Parameter type Parameter type	Production number Assembly list number Order list number Name Comment Subgroup Group Delivery package Material Timbergrade Qualitygrade Count Length Height Width Colour of the part. Values from 0 to 255 are possible. Transparency Planinglength Start offset End offset
<i>Loop over the UIDs and transformations</i>		
UID: TRANSFORMATION:	Integer OX: Parameter type OY: Parameter type OZ: Parameter type XX: Parameter type XY: Parameter type XZ: Parameter type YX: Parameter type YY: Parameter type YZ: Parameter type	Unique Identifier of the part. Every UID may appear only once in the project. If COUNT > 1 for a part, there have to be COUNT UIDs. Coordinate triple origin of the part-coordinate-system Direction vector of the local x axis Direction vector of the local y axis The Transformation describes the position of the part in the project. UIDs and Transformations are optional, but if there are UIDs and Transformations, each UID has to have a Transformation.
<i>End of loop over the UIDs and transformations</i>		

Identification Index	Datotyp	Meaning
CAMBER:	SIDE: Integer (1,2,3,4) P01: Parameter type P02: Parameter type P03: Parameter type P04: Parameter type	Side of part, reference side Distance from beam start to the first point of the arc on the centerline Distance from beam start to the second point of the arc on the centerline Distance from beam start to the third point of the arc on the centerline Camber at third point
PARTOFFSET:	P04: Parameter type P11: Parameter type P12: Parameter type P13: Parameter type P14: Parameter type	Number of reference side placed on fix clamp Offset on reference side 1 Offset on reference side 2 Offset on reference side 3 Offset on reference side 4
PROCESSINGQUALITY:	AUTOMATIC, VISIBLE or FAST	Describes the quality of this part. If this parameter is not set, its value is equal to the PROCESSINGQUALITY, defined in [GENERAL].
OUTLINE:	SIDE: Integer (1,2,3,4) PROCESS: YES or NO P01: Parameter type P02: Parameter type P03: Parameter type P06: Parameter type P08: Parameter type P10: Parameter type P11: Parameter type P12: Parameter type	Outline refers to the coordinate-system of a referenceside of the part If PROCESS is set to YES, then the outline must be machined. If it is set to NO, then the outline is an information about the shape of the workpart. This parameter must appear at the first segment (= point) and is valid for the whole outline. Start- / Endpoint. Inclination of this segment. Type of line. Point on arc. The outline has to be a closed polygon, i.e. the endpoint of the last segment has to be the startpoint of the OUTLINE. Up to 2 OUTLINES may be defined in one part (one on SIDE 1 or 3 and one on SIDE 2 or 4). One OUTLINE is a contour or a contour with an associated contour. If there is a contour with an associated contour, then the contour (first segment with type=100) should be followed directly by the associated contour (first segment with type=101). <i>For details see processing 4-250-X contour. The whole outline is composed of several OUTLINE declarations in the part.</i>

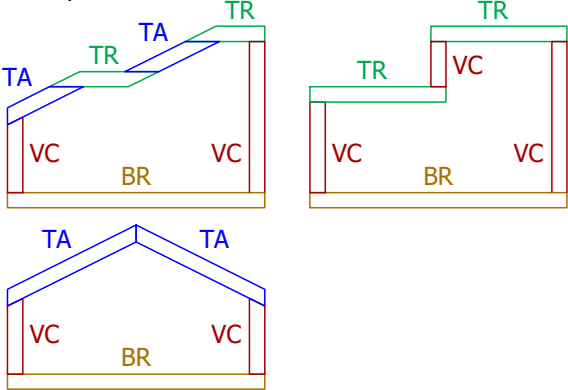
Identification Index	Datatyp	Meaning
	<p style="text-align: center;">AC</p> <p>Endtype-Key can be: R or A or D</p> <p>MATERIALTYPE: BA: String max.256 characters or CL: String max.256 characters or MT: String max.256 characters or ME: String max.256 characters or GB: String max.256 characters or GF: String max.256 characters or IN: String max.256 characters or SH: String max.256 characters or FB: String max.256 characters or PB: String max.256 characters or PL: String max.256 characters</p>	<p>Angled component X-axis (length) of the component is not parallel to the X-axis or Y-axis of the element or the</p> <p>Examples:</p>  <p>Component has rectangular cuts on both ends. Component has an angled cut at one or both ends. Component has a double cut at one or both ends.</p> <p>Battens / Laths Cladding Massive timber, solid wood Membrane / Paper / Foil / Plastic Gypsum Board Gypsum Fibre Insulation material Sheet components (OSB / Fibre) Facade panel Profiled panels, trapezoidal profile Plaster, cast, finish</p> <p>The string after the Materialcode can also be an empty string. Examples: MATERIALTYPE: IN: "109" MATERIALTYPE: BA: ""</p>

Identification Index	Values (format)	Meaning
<i>Loop over the processings</i>		
PROCESSKEY:	Key with format: G-KEY-S DES	G Group: 1,2: separating; 3,4: lying between KEY Key of construction form S Side of part, reference side DES Designation, String max. 256 characters, optional Example: 3-040-2 Drilling
REFERENCEPLANE:	OX: Parameter type OY: Parameter type OZ: Parameter type XX: Parameter type XY: Parameter type XZ: Parameter type YX: Parameter type YY: Parameter type YZ: Parameter type	Coordinate triple origin of the referenceside-coordinate-system Direction vector of the local x axis Direction vector of the local y axis Identifier REFERENCEPLANE is optional. If it is not set, the parameters will have these values: OX/OY/OZ = 0/0/0 XX/XY/XZ = 1/0/0 YX/YY/YZ = 0/1/0 REFERENCEPLANE for a contour 0/3/4-250-X: The REFERENCEPLANE of the first segment (Start-point) is used for the whole contour.
PROCESSPARAMETERS:	P01: Parameter type P02: Parameter type ...	Construction form parameters. Number and meaning of the parameters depend on the construction form to be described. See the following documentation.
PROCESSIDENT:	Integer	All parameters of the processings are optional, missing parameters have the value defined under presettings. Sequential number. This value appears only once in a piece, but can be set again in an other piece.
PROCESSINGQUALITY:	AUTOMATIC, VISIBLE or FAST	Describes the quality of this processing If this parameter is not set, its value is equal to the PROCESSINGQUALITY, defined in [PART].
USERATTRIBUTE:	String max.256 characters : String max.256 characters	First string: attribute name, second: attribute value. This line may appear several times. Example: USERATTRIBUTE: "Price per rm": "11,43 €"
COMMENT: PRIORITY:	String max.256 characters Integer	Comment. This line may appear several times. Processings with high values must be done first. Processings with low values must be done last. If priority is not set, it is assumed to be zero. If two processing have the same priority, the machine can decide in what order the processings should be done.
RECESS:	AUTOMATIC or MANUAL	If this parameter is not set, its value is equal to the RECESS, defined in [PART].
PROCESS:	YES or NO	Describes if the processing should be produced or not. If this parameter is not set, its value is assumed to be YES.
<i>End of loop over the processings</i>		
<i>End of loop over the parts</i>		

3. Caption

1. Part coordinate system

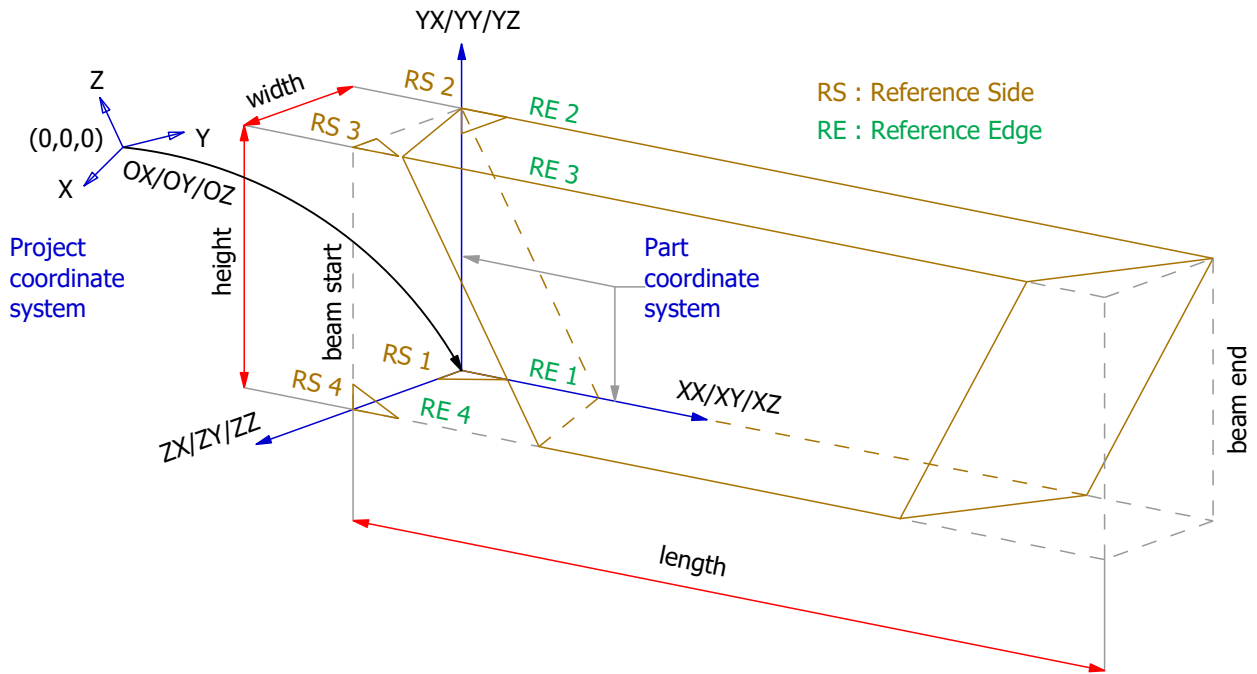

2. Referenceplane

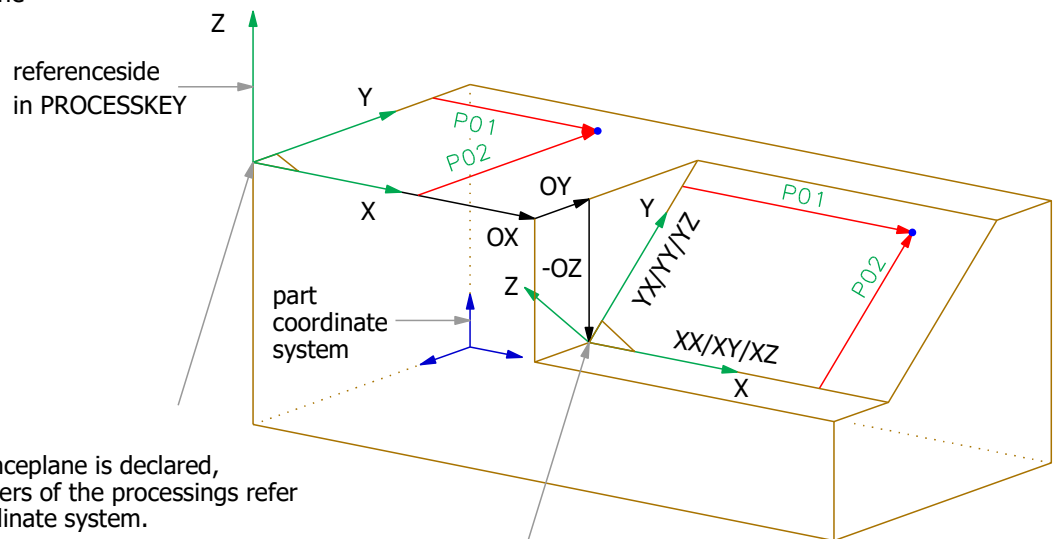

If no referenceplane is declared, the parameters of the processings refer to this coordinate system.

If there is a referenceplane declared, the parameters of the processings refer to this coordinate system.

The referenceplane refers to the referenceside, which is defined in the PROCESSKEY. If the referenceside in the PROCESSKEY is zero, the referenceplane refers to the part coordinate system.

Referenceplane for a contour 0/3/4-250-X:
The REFERENCEPLANE of the first segment (Startpoint) is used for all other segments in this contour.

3. These abbreviations are used in the description of the parameters:

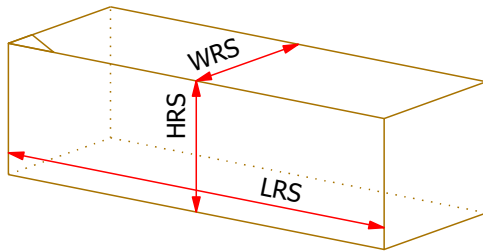

- WRS Width of Reference Side
- HRS Height of Reference Side or "other" component dimension
- LRS Length of Reference Side
 Length of component

4. All parameters are described with a red line or a red arrow.

5. The parameters are shown with their positive value, if there is no special comment like (<0) or (-)

6. The values in the presettings mean "mm" or "degree".

7. Most of the processings are drawn by a view orthogonal to the reference side. Otherwise the zeropoint of the reference side is displayed with a brown line.

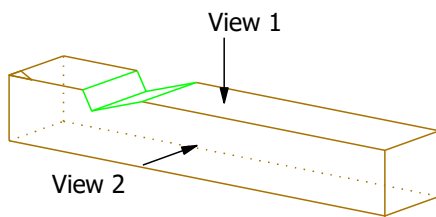

View 1



View 2

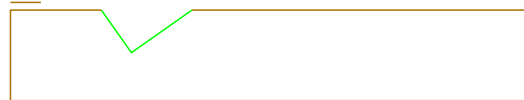

8. SCALEUNIT Position of the decimal point from the right in a "Parameter type"
 The unit of metric parameters is millimeter and the unit of angles is degree.
 Example: If scaleunit=1 the precision is 1/10, if scaleunit=2 the precision is 1/100.
 Each Parameter with format "Parameter type" is multiplied with a scaleunit factor, rounded and written to the btl-file.
 Example: If value of parameter P01 is 123.2345678mm and SCALEUNIT is 2, then P01=00012323.
 And if SCALEUNIT=1, then P01=00001232.
 It is same for parameters, which contain a flag, a bit or an integer value like P04 for Lap Joint.
 Example: If value of parameter P04 is 15 and scaleunit is 2, then P01=00001500.
 And if scaleunit=1, then P01=00000150.

9. Examples for values in the BTL file

Format		example	value
String max.256 characters	Text must be in quotes	LISTNAME : "Dach "	
Integer		SINGLEMEMBERNUMBER : 1 SCALEUNIT : 2	1 2
Parameter type = String 8 characters (RANGE: STANDARD)	SCALEUNIT: 2 SCALEUNIT: 3	P07: 00123456 P08: 00-23456 P07: 00123456 P08: 00-23456	P07=1234,56 P08=-234,56 P07=123,456 P08=-23,456
Parameter type = String 12 characters (RANGE: EXTENDED)	SCALEUNIT: 2 SCALEUNIT: 3	P07: 000123456789 P08: 000-23456789 P07: 000123456789 P08: 000-23456789	P07=1234567,89 P08=-234567,89 P07=123456,789 P08=-23456,789

10. Part in a rawpart, part in composite, composite in composite

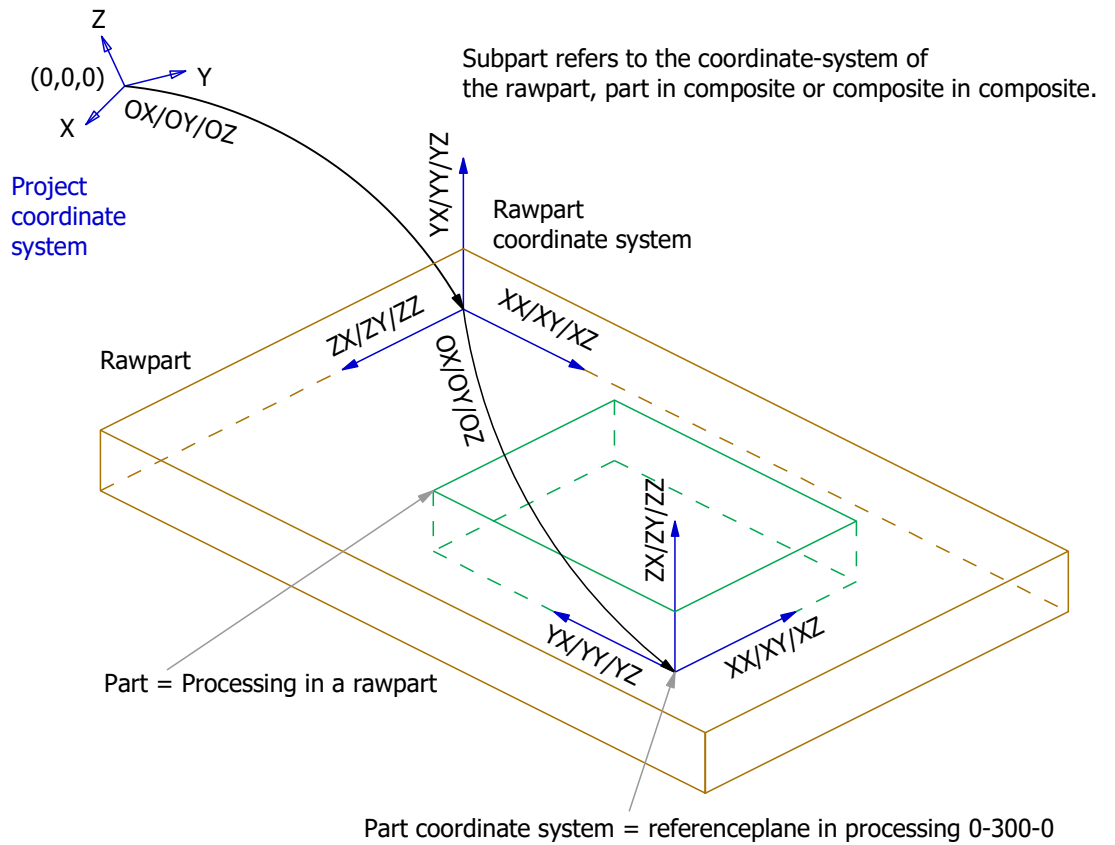

11. Camber

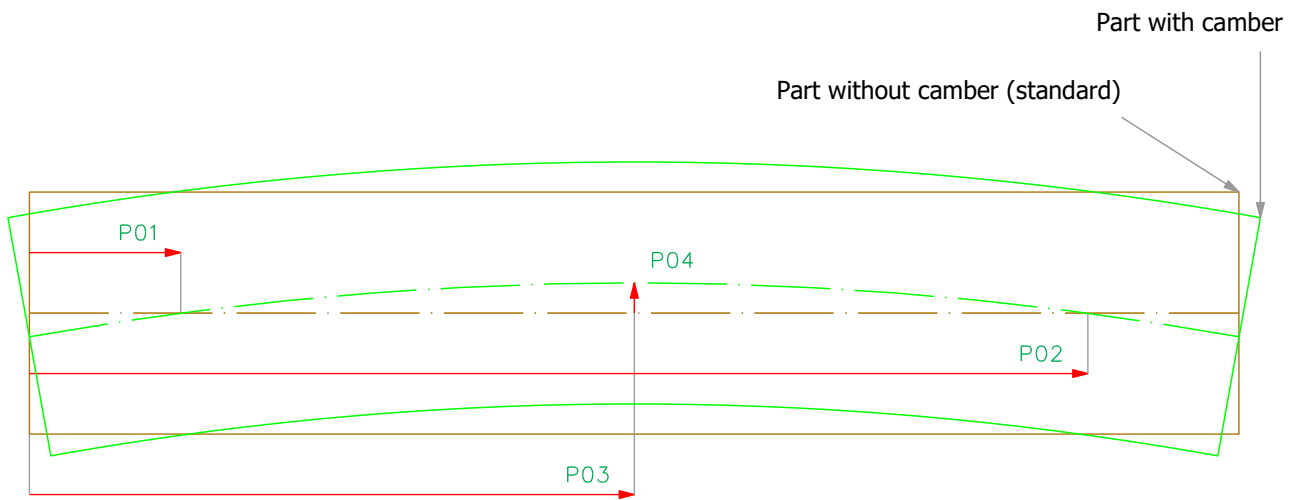

All processings are defined in the part without camber.

4. Example File

```
VERSION: "BTL V10.6"
BUILD: "10601"
[GENERAL]
PROJECTNUMBER: "043"
PROJECTNAME: "Company Warehouse"
PROJECTPART: ""
LISTNAME: "Roof"
CUSTOMER: ""
ARCHITECT: ""
EDITOR: "Smith"
DELIVERYDATE: "2006-11-30"
EXPORTDATE: "2006-09-26"
EXPORTTIME: "09:20:11"
EXPORTRELEASE: "SEMA Holzbausoftware V10.2 (de) Build 10461"
LANGUAGE: "DE"
SCALEUNIT: 1
COMPUTERNAME: "My Computer"
USER: "Jones"
COMMENT: "043"
COMMENT: "010"
COMMENT: "Company Warehouse"
COMMENT: "Sussex"
COMMENT: "Smith"
COMMENT: "15"
COMMENT: "J. Doe"
COMMENT: ""
[PART]
SINGLEMEMBERNUMBER: 1
ASSEMBLYNUMBER: ""
ORDERNUMBER: 1
DESIGNATION: "Purlin"
ANNOTATION: "B:1 Nr:1"
STOREY: "DG1"
GROUP: "01"
PACKAGE: "1"
MATERIAL: "Redwood"
TIMBERGRADE: "BSH"
QUALITYGRADE: "S10"
COUNT: 1
LENGTH: 00146700
HEIGHT: 00002400
WIDTH: 00001800
PLANINGLENGTH: 00022700
STARTOFFSET: 00000200
ENDOFFSET: 00000200
TRANSFORMATION: OX:00000000 OY:00000000 OZ:00000000 XX:00010000 XY:00000000
XZ:00000000 YX:00000000 YY:00010000 YZ:00000000
PARTOFFSET: P04:00000010 P11:00000000 P12:00000500 P13:00000000 P14:00000000
```

PROCESSKEY: 2-010-2 Saw Cut
PROCESSPARAMETERS: P01:00000000 P02:00000000 P03:00000000 P06:00000900 P07:00000900
PROCESSIDENT: 1
PROCESSKEY: 4-090-1 Planing
PROCESSPARAMETERS: P01:00000000 P04:00001240 P11:00000000 P12:00011350
PROCESSIDENT: 2
PROCESSKEY: 4-060-3 Marking
PROCESSPARAMETERS: P01:00131250 P06:00000900 P11:00000800 P13:00000010 P14:01310740
PROCESSIDENT: 3
PROCESSKEY: 4-090-1 Planing
PROCESSPARAMETERS: P01:00135350 P04:00001240 P11:00000000 P12:00011350
PROCESSIDENT: 4
PROCESSKEY: 1-010-2 Saw Cut
PROCESSPARAMETERS: P01:00146700 P02:00000000 P03:00000000 P06:00000900 P07:00000900
PROCESSIDENT: 5
[PART]
SINGLEMEMBERNUMBER: 2
ASSEMBLYNUMBER: ""
ORDERNUMBER: 2
DESIGNATION: "Rafter"
ANNOTATION: "B:1 Nr:1"
STOREY: "DG1"
GROUP: "01"
PACKAGE: "1"
MATERIAL: "Oak"
TIMBERGRADE: "KVH"
QUALITYGRADE: "S13"
COUNT: 1
LENGTH: 00067936
HEIGHT: 00001800
WIDTH: 00000800
PLANINGLENGTH: 00014610
STARTOFFSET: 00000200
ENDOFFSET: 00000200
TRANSFORMATION: OX:00000000 OY:00000000 OZ:00000000 XX:00010000 XY:00000000
XZ:00000000 YX:00000000 YY:00010000 YZ:00000000
PARTOFFSET: P04:00000010 P11:00000000 P12:00000500 P13:00000000 P14:00000000
PROCESSKEY: 2-011-2 Double Cut
PROCESSPARAMETERS: P02:00001260 P06:00000900 P07:00000900 P08:00000350 P09:00000900
PROCESSIDENT: 1
PROCESSKEY: 4-090-1 Planing
PROCESSPARAMETERS: P01:00000000 P04:00001240 P11:00000000 P12:00014611
PROCESSIDENT: 2
PROCESSKEY: 4-020-1 Birds Mouth
PROCESSPARAMETERS: P01:00021778 P06:00000900 P07:00000350 P08:00001250
P11:00000300 P12:00000300
PROCESSIDENT: 3
PROCESSKEY: 1-010-2 Saw Cut
PROCESSPARAMETERS: P01:00067936 P02:00000000 P03:00000000 P06:00000550 P07:00000900
PROCESSIDENT: 4

5. Table of Contents, List of processings

Processing	Process Key	Page
Cut	1/2-010-X	18
Longitudinal Cut	0/3/4-010-X	20
Double Cut	1/2-011-X	22
Ridge or Valley Cut	0-012-X	24
Saw Cut	0/3/4-013-X	26
Slot	3/4-016-X	28
Front Slot	3/4-017-X	32
Birds Mouth	3/4-020-X	34
Hip or Valley Rafter Notch	3/4-025-X	39
Ridge Lap	1/2-030-X	41
Lap Joint	3/4-030-X	44
Notch / Rabbet	3/4-032-X	48
Block House Half Lap, Stair Riser Dado	3/4-033-X	50
Seathing Cut	3/4-034-X	52
French Ridge Lap	1/2-035-X	54
Chamfer	3/4-036-X	56
Block House Half Lap	4-037-X	58
Block House Front	3/4-038-X	61
Pocket	4-039-X	63
Drilling	3/4-040-X	65
Tenon	1/2-050-X	67
Mortise	3/4-050-X	69
Mortise Front	3/4-051-X	71
House	3/4-052-X	73
House Mortise	3/4-053-X	75
Dovetail Tenon	1/2-055-X	77
Dovetail Mortise	3/4-055-X	79
Dovetail Mortise Front	3/4-056-X	81
Marking / Labeling	3/4-060-X	83
Text	4-061-X	86
Simple Scarf	1/2-070-X	88
Scarf Joint	1/2-071-X	90
Step Joint	1/2-080-X	92
Step Joint Notch	3/4-080-X	94
Planing	3/4-090-X	96
Profile Front	3/4-100-X	98
Profile Head concave	3/4-101-X	100
Profile Head convex	3/4-102-X	102
Profile Head cambered	3/4-103-X	104
Round Arch	4-104-X	106
Profile Head	3/4-106-X	108
Sphere	3/4-107-X	110
Triangle Cut	4-120-X	112
Tyrolean Dovetail	1/2/3/4-136-X	114
Dovetail	1/2/3/4-138-X	123
Free Contour	0/3/4-250-X	126
Variant	0/1/2/3/4-900-X	130

6. Description of processings

Cut 1-010-X and 2-010-X

2-010-X

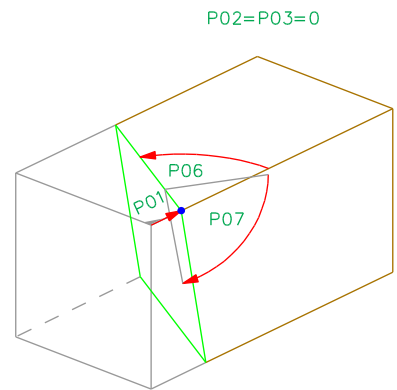
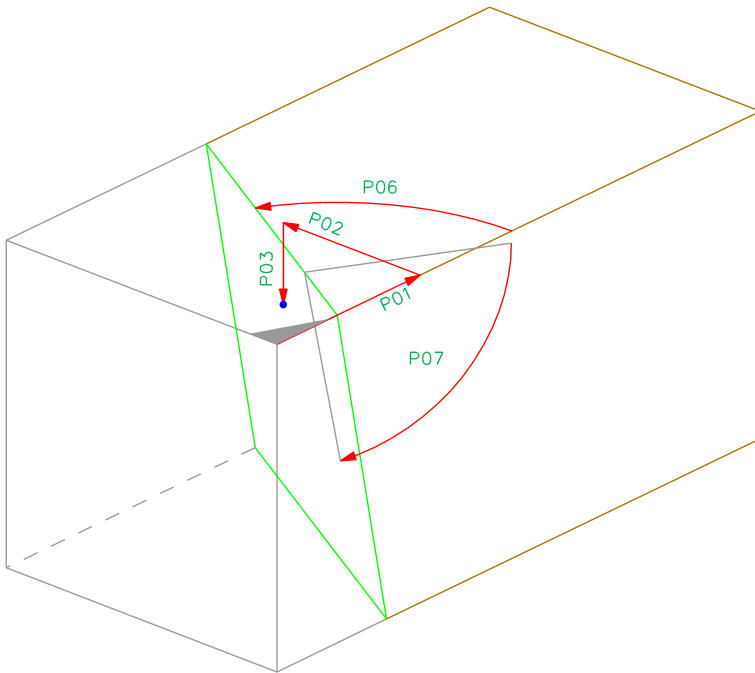

1-010-X

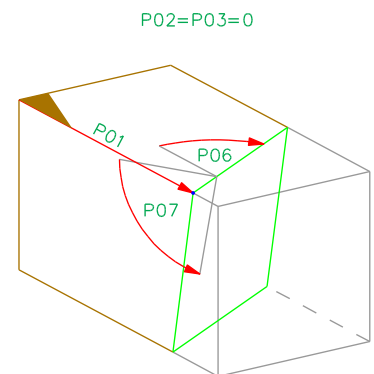
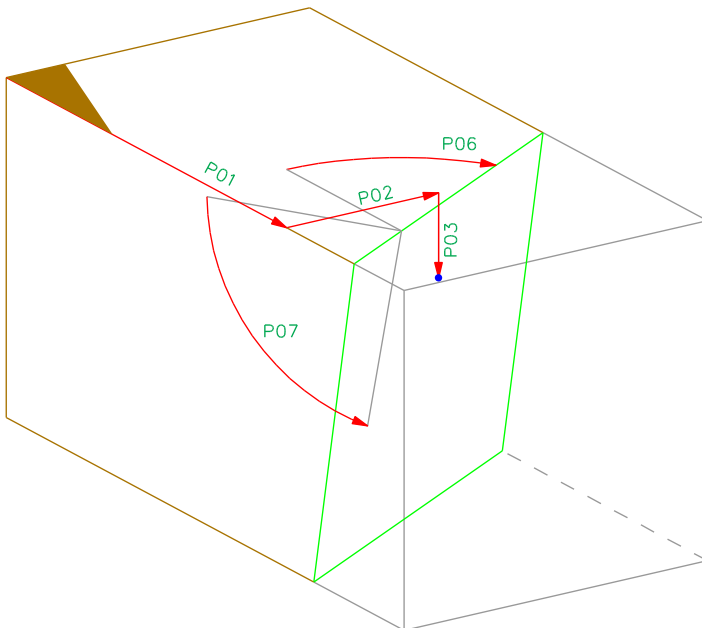

Parameters Cut

1-010-X and 2-010-X

Parameter	Min/Max	Presetting	Description
P01	+/- 99999	0	Distance from beam start to the reference point
P02	0/50000	0	Distance from the reference edge to the reference point
P03	0/50000	0	Distance from the reference side to the reference point (orthogonal)
P06	0.1 / 179.9	90	Angle between cut edge and reference edge
P07	0.1 / 179.9	90	Inclination between face and reference side

Longitudinal Cut 0-010-X / 3-010-X / 4-010-X

P07 > 0

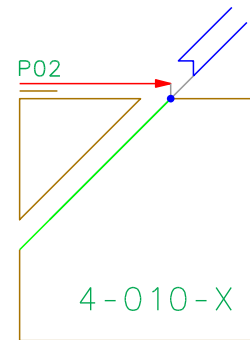
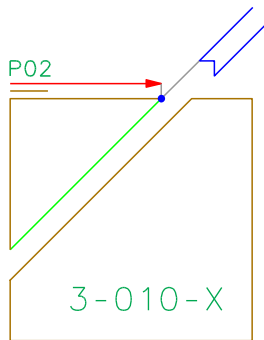
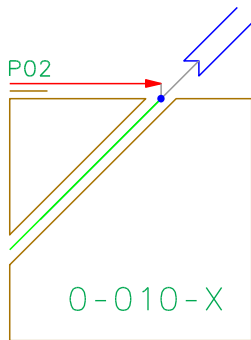
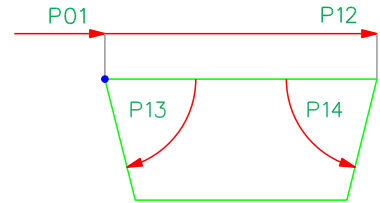
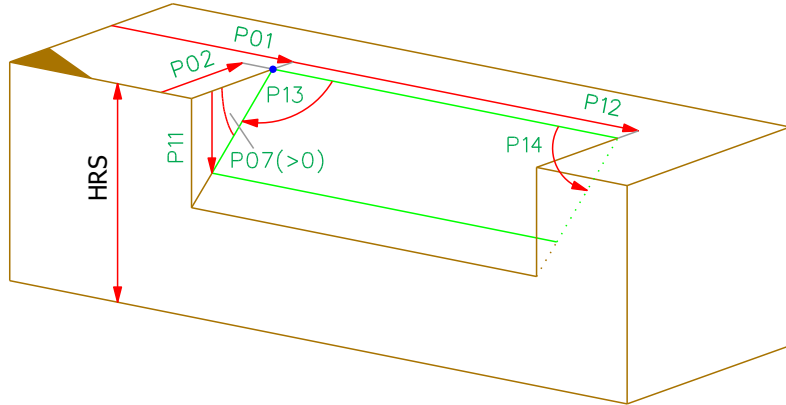

P07 < 0

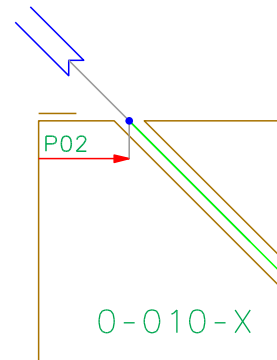
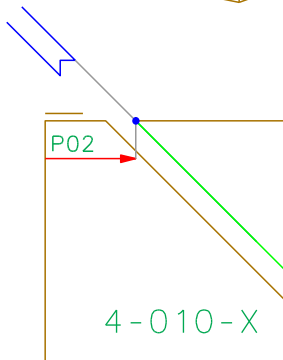
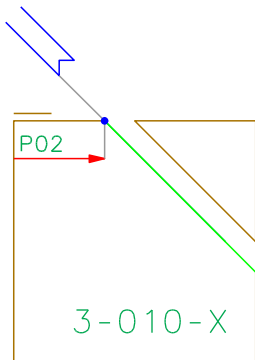
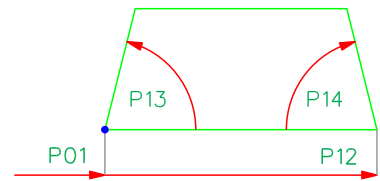
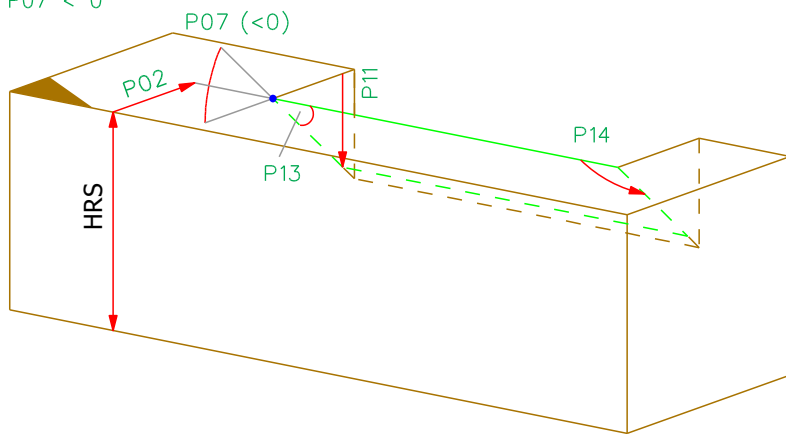



Parameters Longitudinal Cut

0-010-X / 3-010-X / 4-010-X

Parameter	Min/Max	Presetting	Description
P01	+/- 99999	0	Distance from beam start to the reference point
P02	+/- 50000	20	Distance from the reference edge to the reference point
P04	0/7	0	Limit of the 2 ends, binary code
P07	-90/90	45	Inclination to the reference side
P11	0/50000	0	Depth If P11 is zero, then the face of the cut dispreads to the neighbour-sides or opposite-side to referenceside.
P12	0/99999	0	Length If P12 and P04 equal to zero, the processing is performed along the whole component length
P13	1/179	90	Angle in face at start
P14	1/179	90	Angle in face at end

Position of the tool:

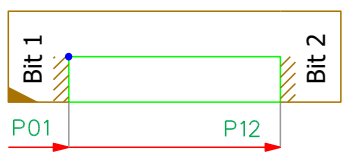
- Group 0: Saw guide in the middle
- Group 3: Saw guide opposite the reference edge
- Group 4: Saw guide towards the reference edge

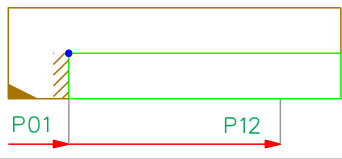
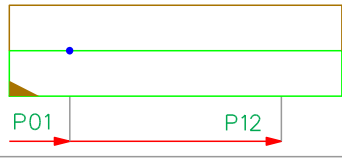
		P04			
Bit	0	1	2		
Value	1	2	4		
	0	0	0	0	P12 > 0: Length of processing P12 = 0: Processing is performed along the whole part length.
	1	0	0	1	
	1	1	0	3	
	1	0	1	5	
	1	1	1	7	

Double Cut 1-011-X and 2-011-X

2-011-X

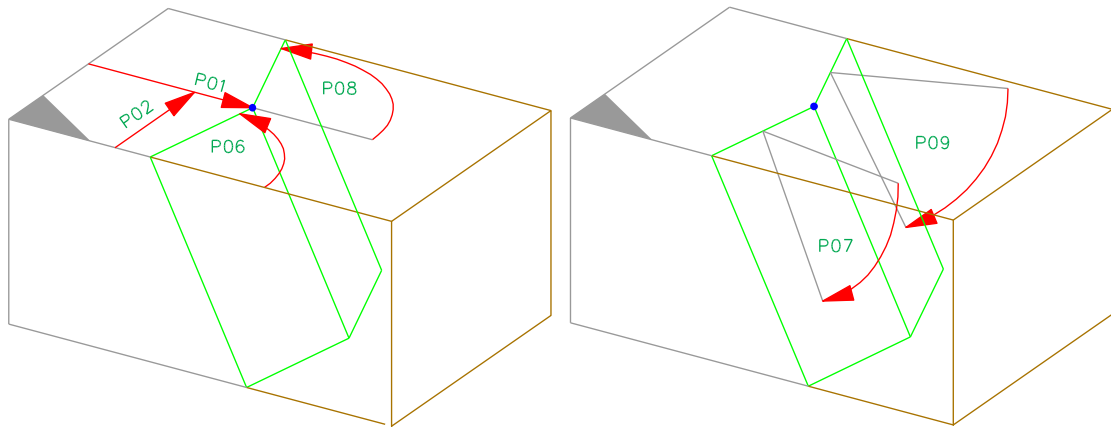

1-011-X

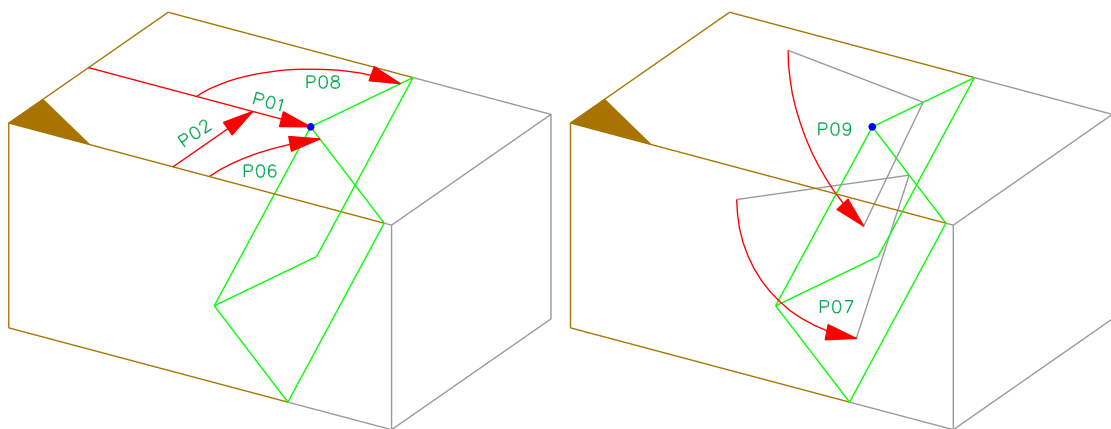

Parameters Double Cut

1-011-X and 2-011-X

Parameter	Min/Max	Presetting	Description
P01	+/- 99999	0	Distance from beam start to the reference point
P02	+/- 50000	50	Distance from the reference point to the reference edge
P06	1/179	45	Angle between the first cutting edge and the reference edge
P07	1/179	90	Inclination of the first cutting towards the reference side
P08	1/179	90	Angle between the second cutting edge and the reference edge
P09	1/179	90	Inclination of the second cutting towards the reference side

Ridge or Valley Cut 0-012-X

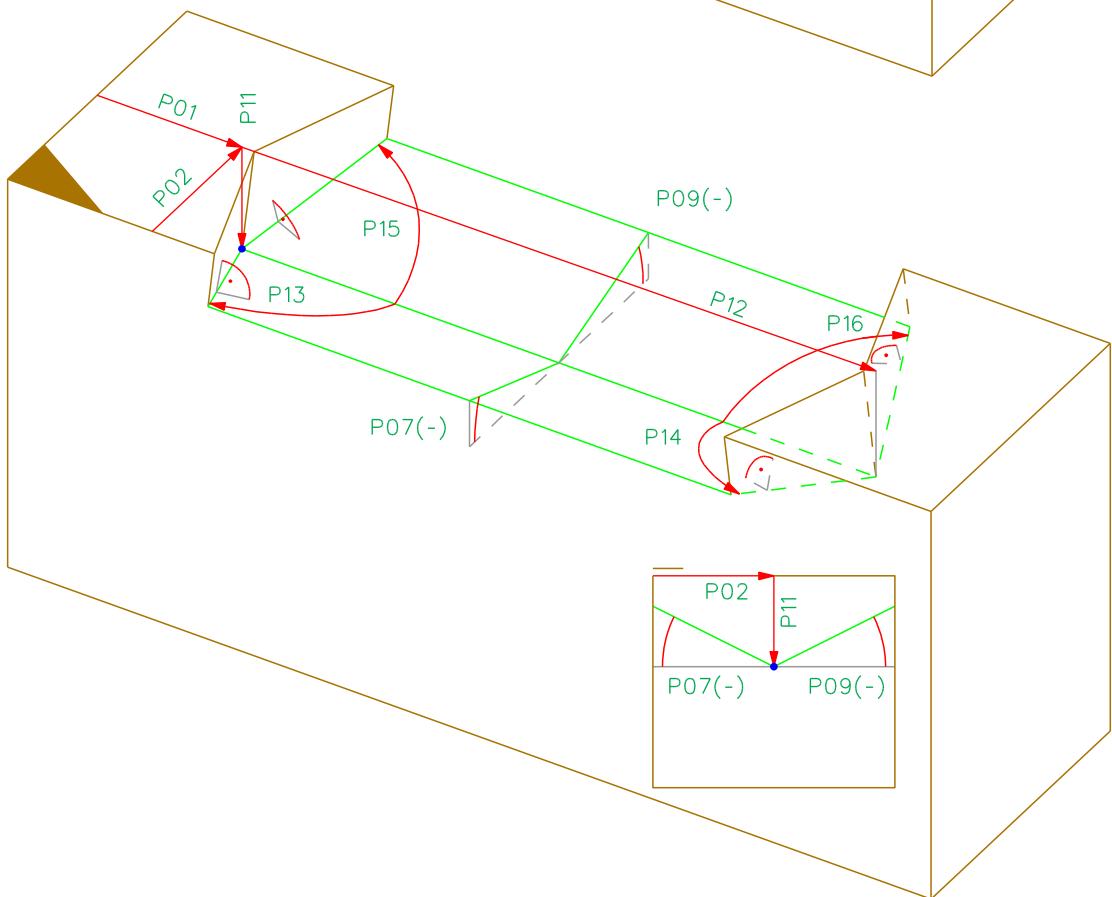
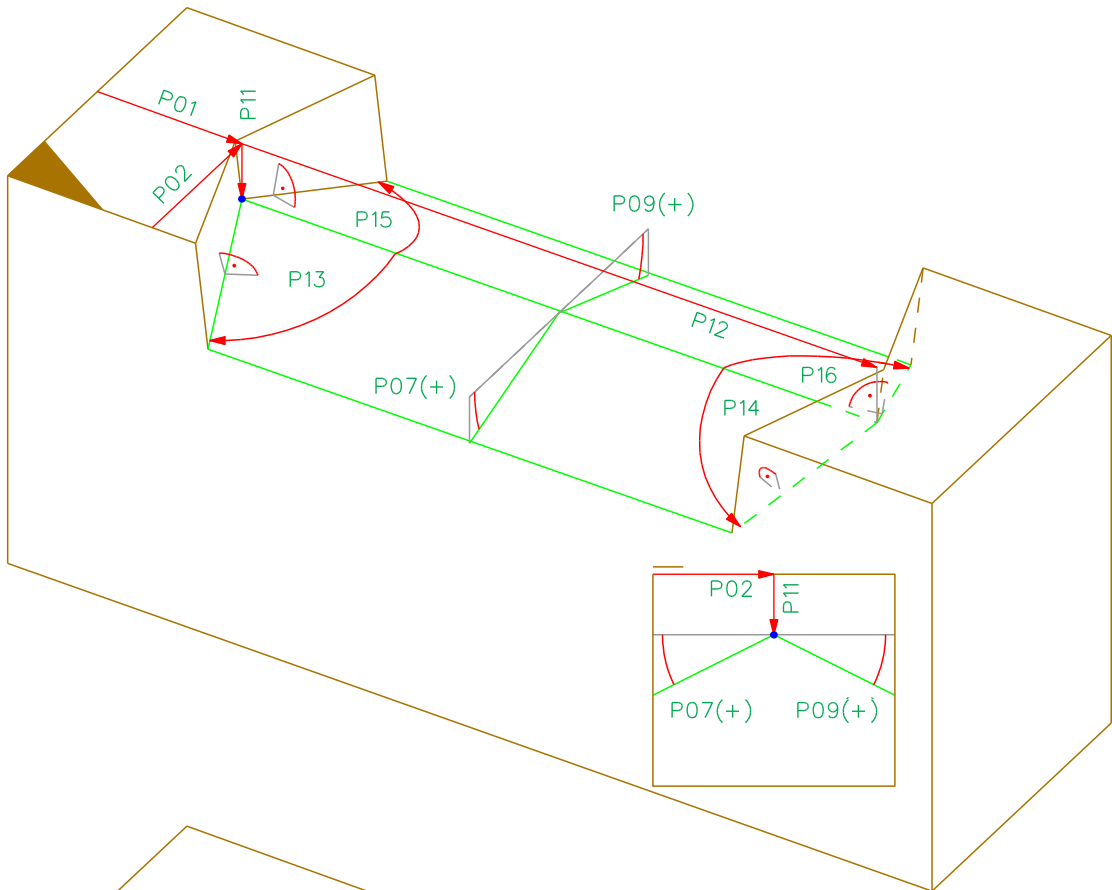

0-012-X



Parameters Ridge or Valley Cut

0-012-X

Parameter	Min/Max	Presetting	Description
P01	+/- 99999	0	Distance from beam start to the reference point
P02	0/50000	WRS/2	Distance from the reference point to the reference edge
P04	0/7	0	Limit of the 2 ends, binary code
P07	-89/89	45	Inclination between the first face and the reference side
P09	-89/89	45	Inclination between the second face and the reference side
P11	+/- 99999	0	Depth
P12	0/99999	0	Length If P12 and P04 equal to zero, the processing is performed along the whole component length
P13	1/179	90	Angle in face at reference edge at start
P14	1/179	90	Angle in face at reference edge at end
P15	1/179	90	Angle in face in opposite to reference edge at start
P16	1/179	90	Angle in face in opposite to reference edge at end

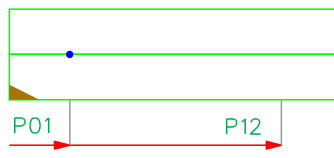
		P04			
Bit	0	1	2		
Value	1	2	4		
	0	0	0	0	P12 > 0: Length of processing P12 = 0: Processing is performed along the whole part length.
	1	0	0	1	
	1	1	0	3	
	1	0	1	5	
	1	1	1	7	

Saw Cut 0-013-X / 3-013-X / 4-013-X

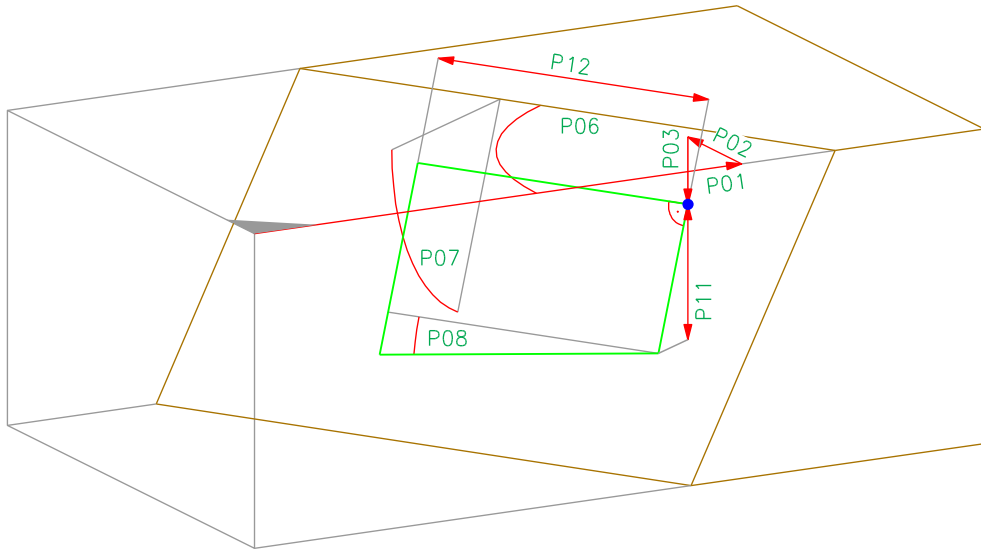

4-013-X

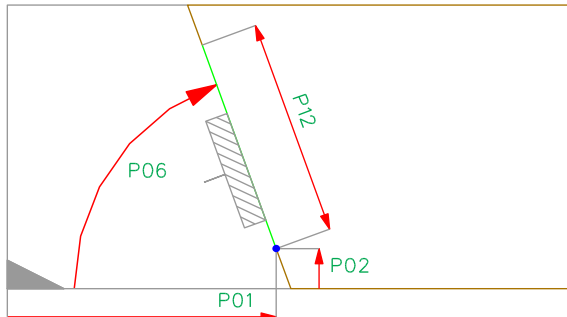

3-013-X

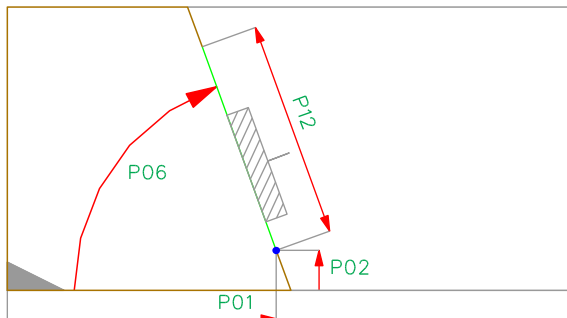

0-013-X

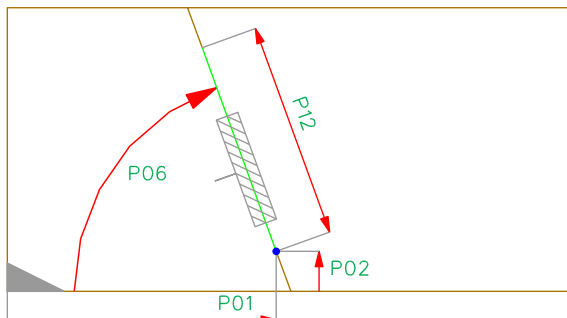

Parameters Saw Cut

0-013-X / 3-013-X / 4-013-X

Parameter	Min/Max	Presetting	Description
P01	+/- 99999	0	Distance from beam start to the reference point
P02	+/- 50000	0	Distance from the reference point to the reference edge
P03	+/- 50000	0	Displacement to the reference side
P06	+/- 180	90	Angle between cut edge and reference edge
P07	1/179	90	Inclination to the reference side
P08	+/- 89	0	Angle to the reference edge in the cut face
P11	0/50000	HRS/2	Depth, orthogonal to the reference side
P12	1/99999	WRS	Length

Slot 3-016-X and 4-016-X

4-016-X

P03 = 0

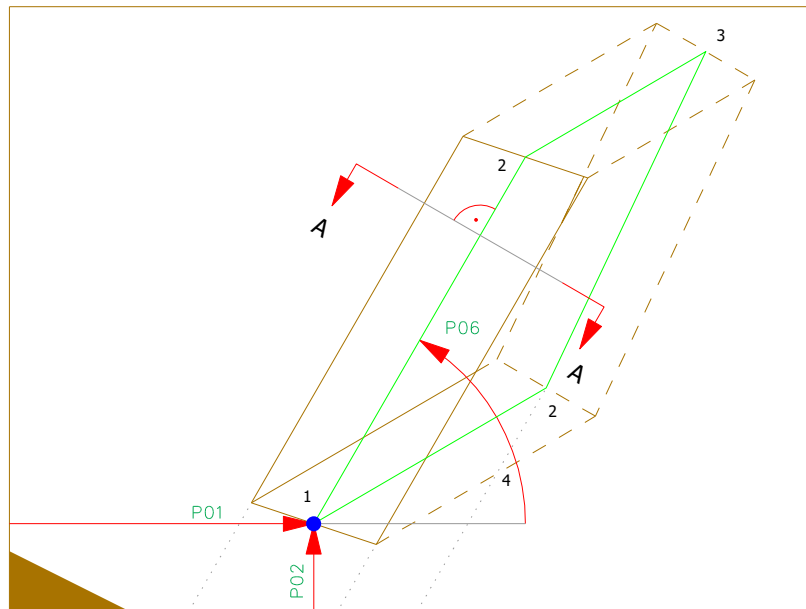
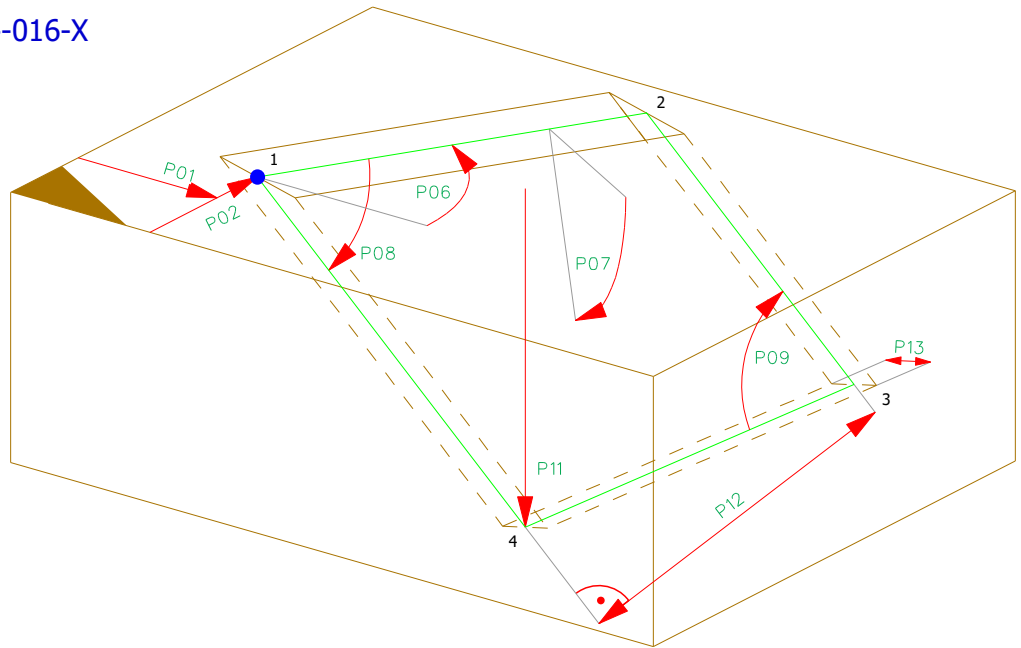

A - A

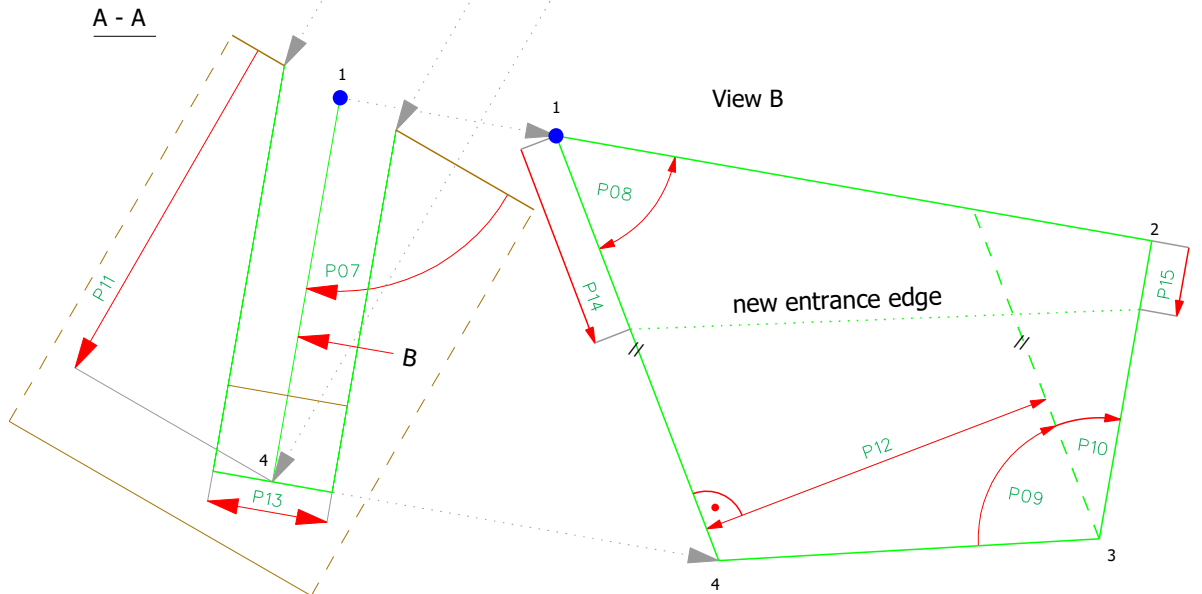

P04

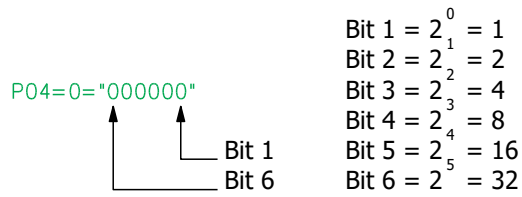

P04=0="xx0000"

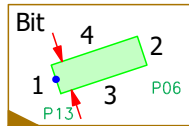

P04=1="xx0001"

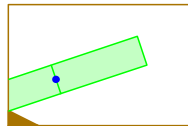

P04=2="xx0010"

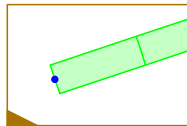

P04=3="xx0011"

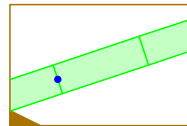

P04=4="xx0100"

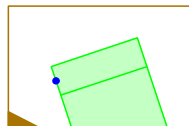

P04=5="xx0101"

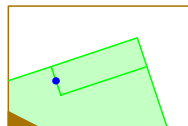

P04=6="xx0110"

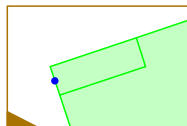

P04=7="xx0111"

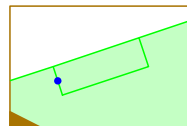

P04=8="xx1000"

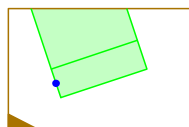

P04=9="xx1001"

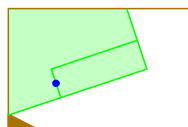

P04=10="xx1010"

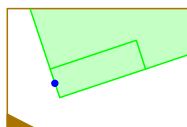

P04=11="xx1011"

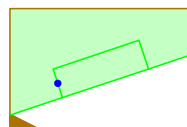

P04=12="xx1100"

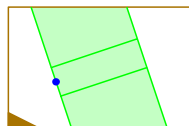

P04=13="xx1101"

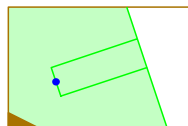

P04=14="xx1110"

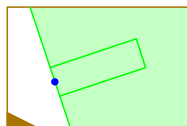

P04=15="xx1111"

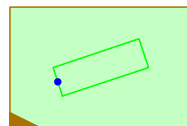

P04="00xxxx"

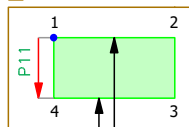

P04="01xxxx"

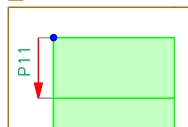

P04="10xxxx"

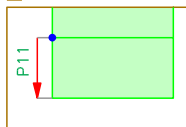

P11="11xxxx"

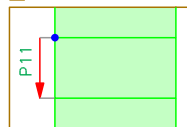

Bit 6 (Enter edge of slot)
 Bit 5 (Bottom of slot)

P03 > 0

4-016-X

3-016-X

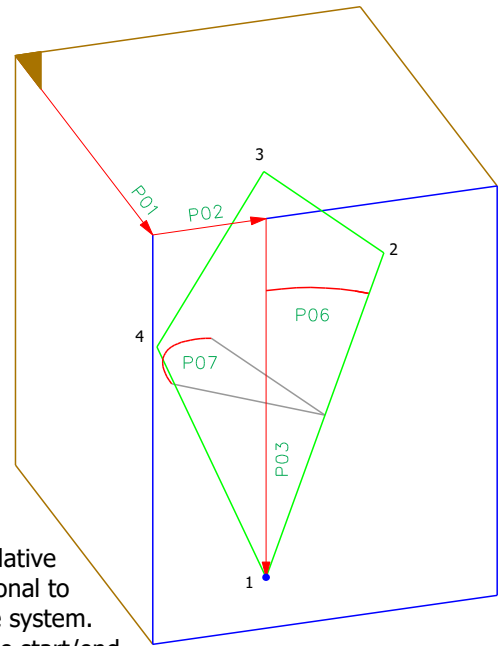
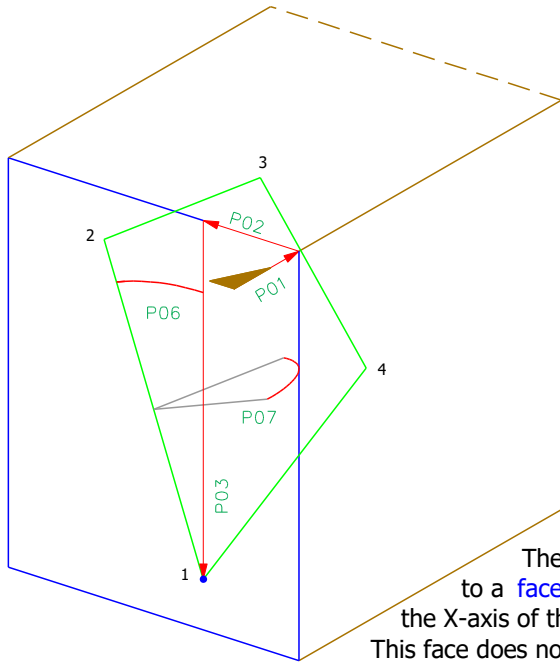

The slot is defined relative to a **face**, which is orthogonal to the X-axis of the part coordinate system. This face does not have to be at the start/end of the beam.

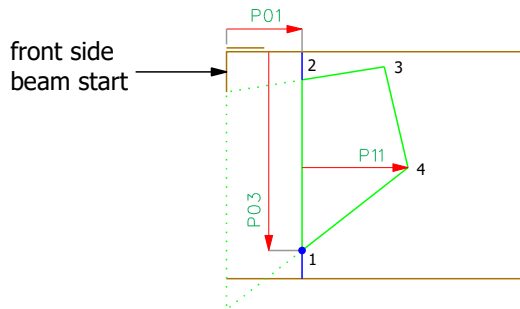

The slot is not limited towards the front sides when P03>0.

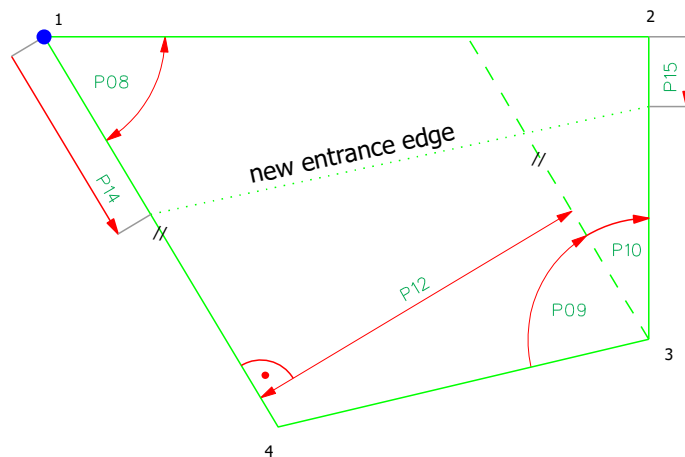
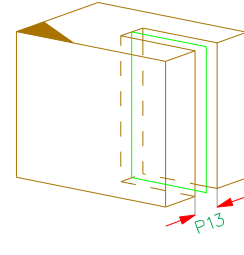
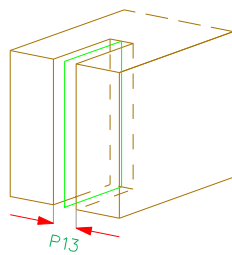
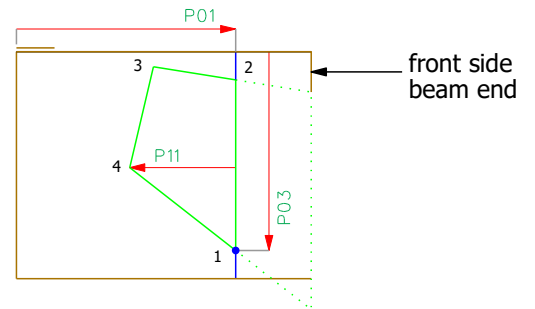

Parameters Slot

3-016-X and 4-016-X

Parameter	Min/Max	Presetting	Description
P01	+/- 99999	0	Distance from beam start to the reference point
P02	+/- 50000	0	Distance from the reference edge to the reference point
P03	0/50000	0	Distance to the reference point orthogonal to the reference side P03 = 0: Slot on one of the 4 sides of the component. P03 > 0: Slot on one of the 2 front sides of the component
P04	0/63	0	Limit of the 6 faces of the slot, binary code
P06	-90/90	0	Angle to the reference edge in the reference side
P07	1/179	90	Inclination to the reference side
P08	1/179	90	Interior angle at reference point
P09	1/179	90	Interior angle at opposite of reference point
P10	1-P09/179-P09	0	Addition to P09
P11	1/50000	100	Depth orthogonal to the reference side
P12	1/99999	200	Length
P13	1/50000	10	Thickness
P14	+/- 50000	0	Displacement of the entrance edge at reference point
P15	+/- 50000	0	Displacement of the entrance edge at opposite of reference point

Front Slot 3-017-X and 4-017-X

4-017-X

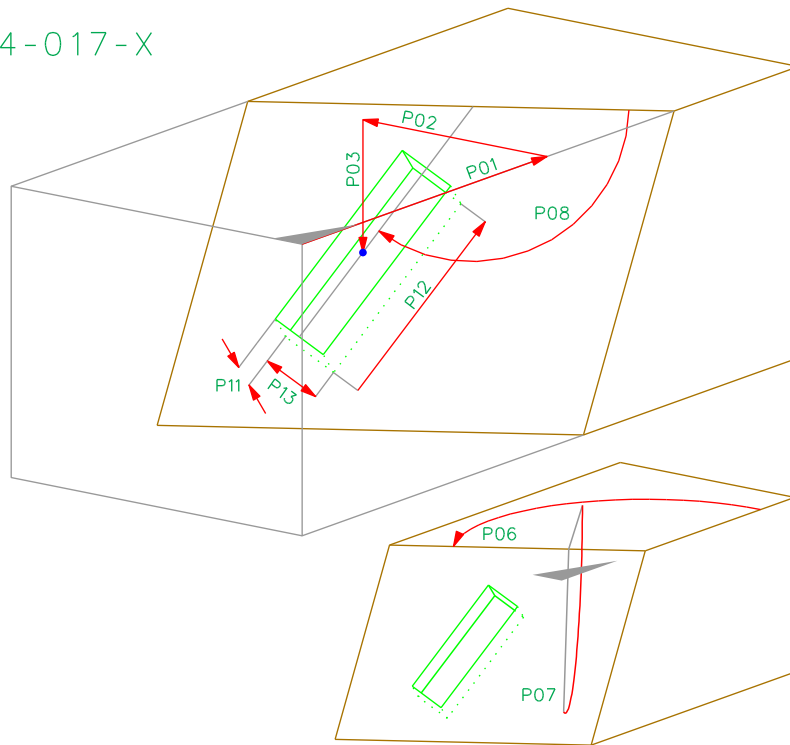

3-017-X

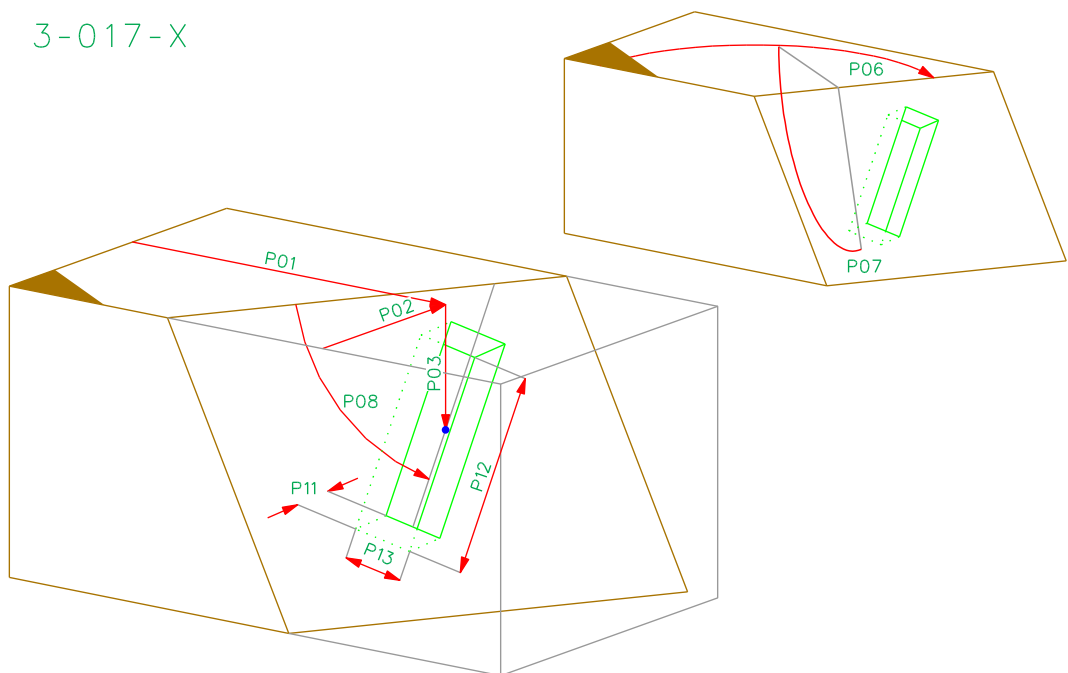

Parameters Front Slot

3-017-X and 4-017-X

Parameter	Min/Max	Presetting	Description
P01	+/- 99999	0	Distance from beam start to the reference point
P02	+/- 50000	0	Distance from the reference point to the reference edge
P03	0/50000	0	Distance to the reference point orthogonal to the reference side
P04	0/63	0	Limit of the 6 faces of the Frotn Slot, binary code
P06	1/179	90	Angle between cut edge and reference edge
P07	1/179	90	Inclination to the reference side
P08	0/360	90	Angle between the longitudinal axis of the slot and the reference side
P11	0/50000	20	Depth
P12	0/50000	40	Length
P13	0/50000	40	Width

P04

4-017-X

3-017-X

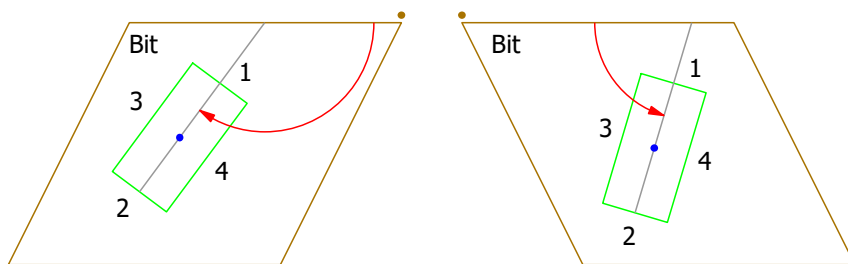

- Bit 1 = $2^0 = 1$
- Bit 2 = $2^1 = 2$
- Bit 3 = $2^2 = 4$
- Bit 4 = $2^3 = 8$
- Bit 5 = $2^4 = 16$
- Bit 6 = $2^5 = 32$

P04=0="xx0000"

P04=1="xx0001"

P04=2="xx0010"

P04=3="xx0011"

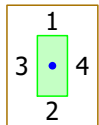

here:
P08=90

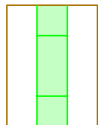
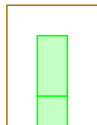
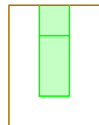

P04=4="xx0100"

P04=5="xx0101"

P04=6="xx0110"

P04=7="xx0111"

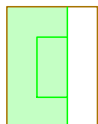
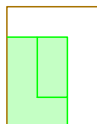
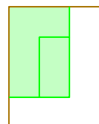
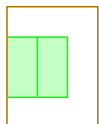

P04=8="xx1000"

P04=9="xx1001"

P04=10="xx1010"

P04=11="xx1011"

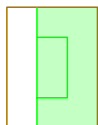
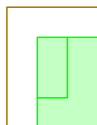
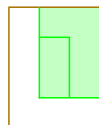
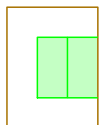

P04=12="xx1100"

P04=13="xx1101"

P04=14="xx1110"

P04=15="xx1111"

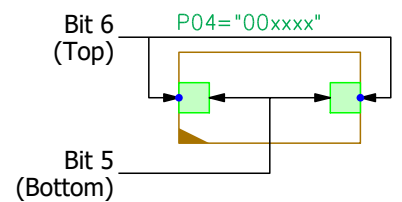
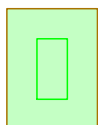
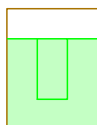
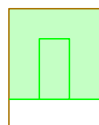
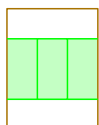

P04="01xxxx"

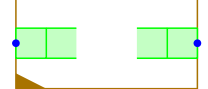

P04="10xxxx"



P04="11xxxx"

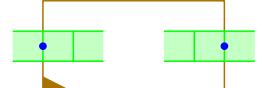

3-020-X

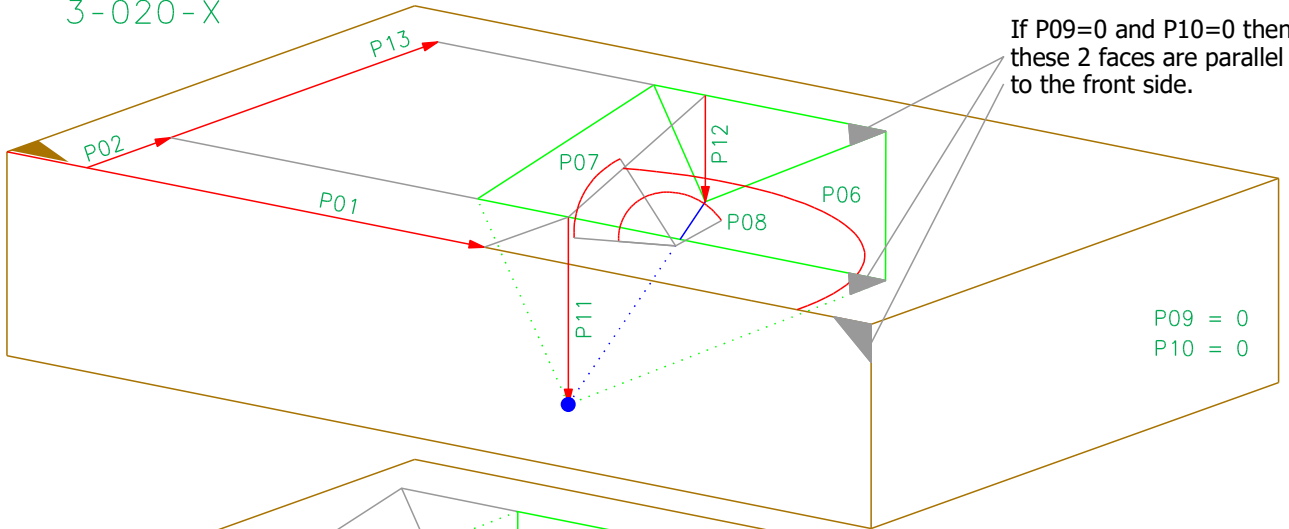

P09 = 0
P10 = 0

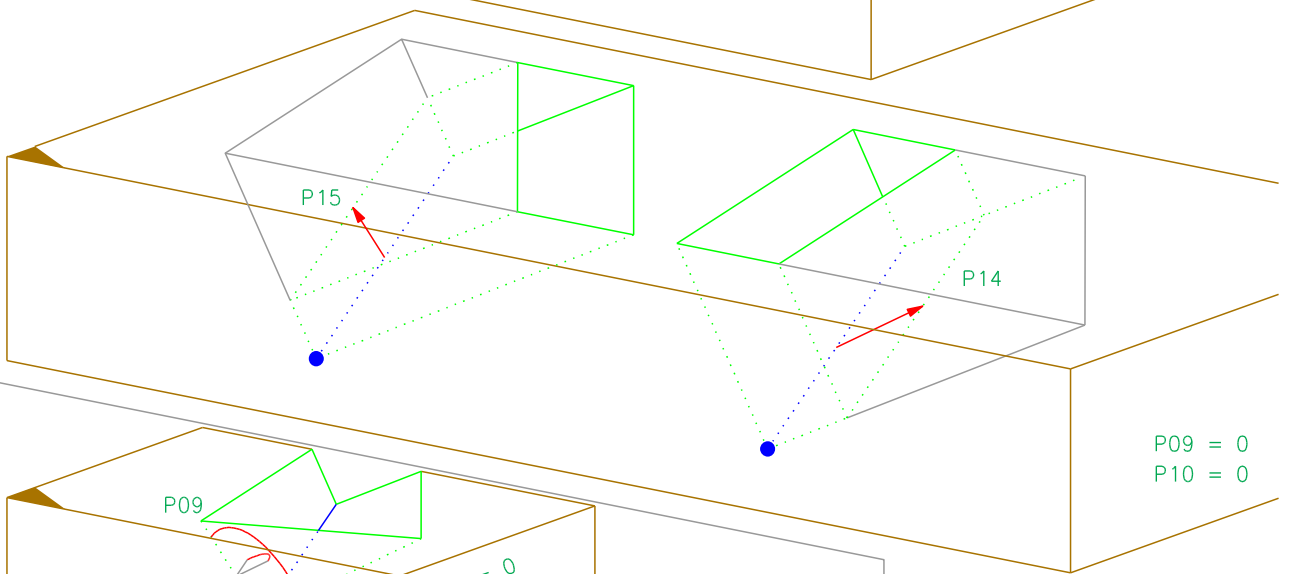

P09 = 0
P10 = 0

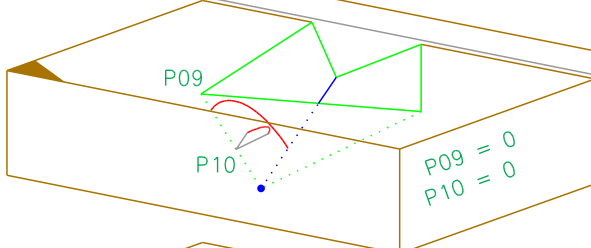

P09 = 0
P10 = 0

Location of P09/P10:
P04 defines the location
of P09/P10.

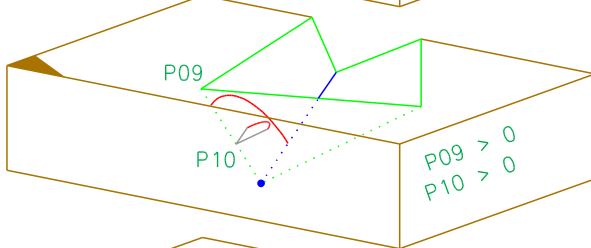

P09 > 0
P10 > 0

Bit 3 = 0
Bit 4 = 1
P04 = 8

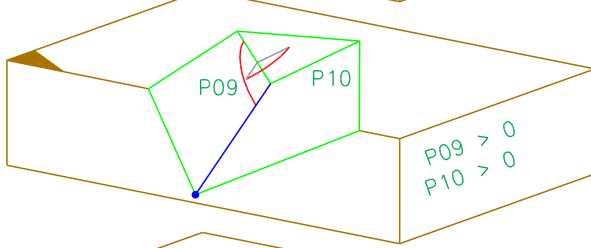

P09 > 0
P10 > 0

Bit 3 = 1
Bit 4 = 0
P04 = 4

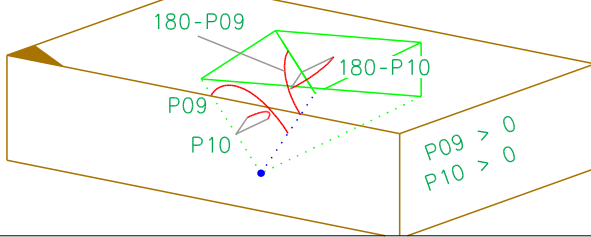

P09 > 0
P10 > 0

Bit 3 = 0
Bit 4 = 0
P04 = 0

Simple example

P02=0 P11=P12
P06=90 P13=WRS

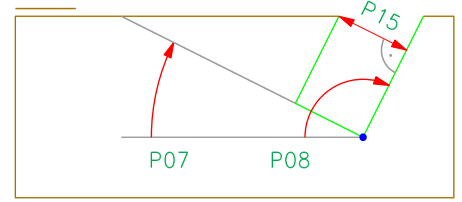
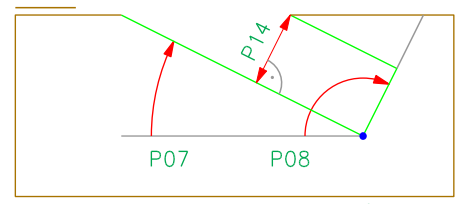
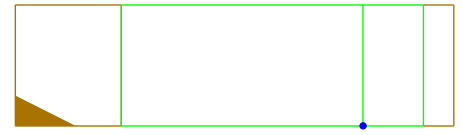

3-020-X

Another presentation of parameters P07, P08

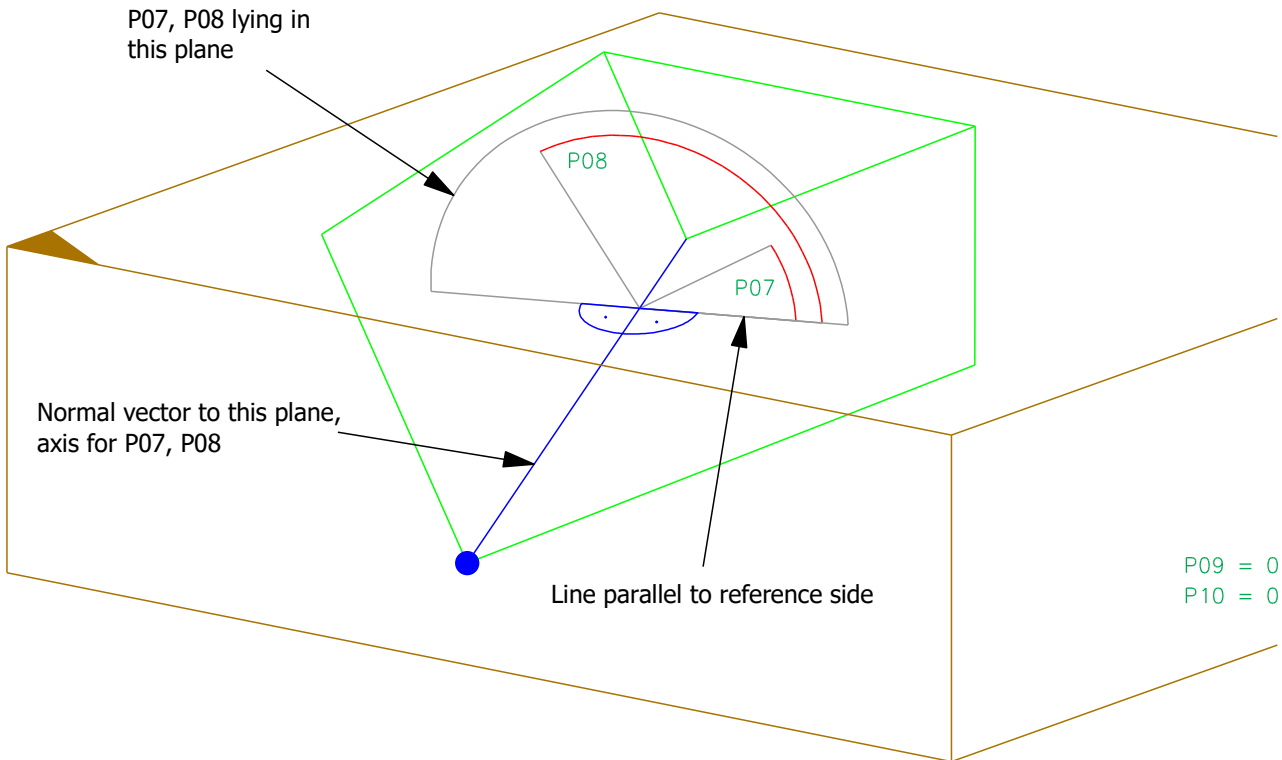

3-020-X

Another presentation of parameters P07, P08

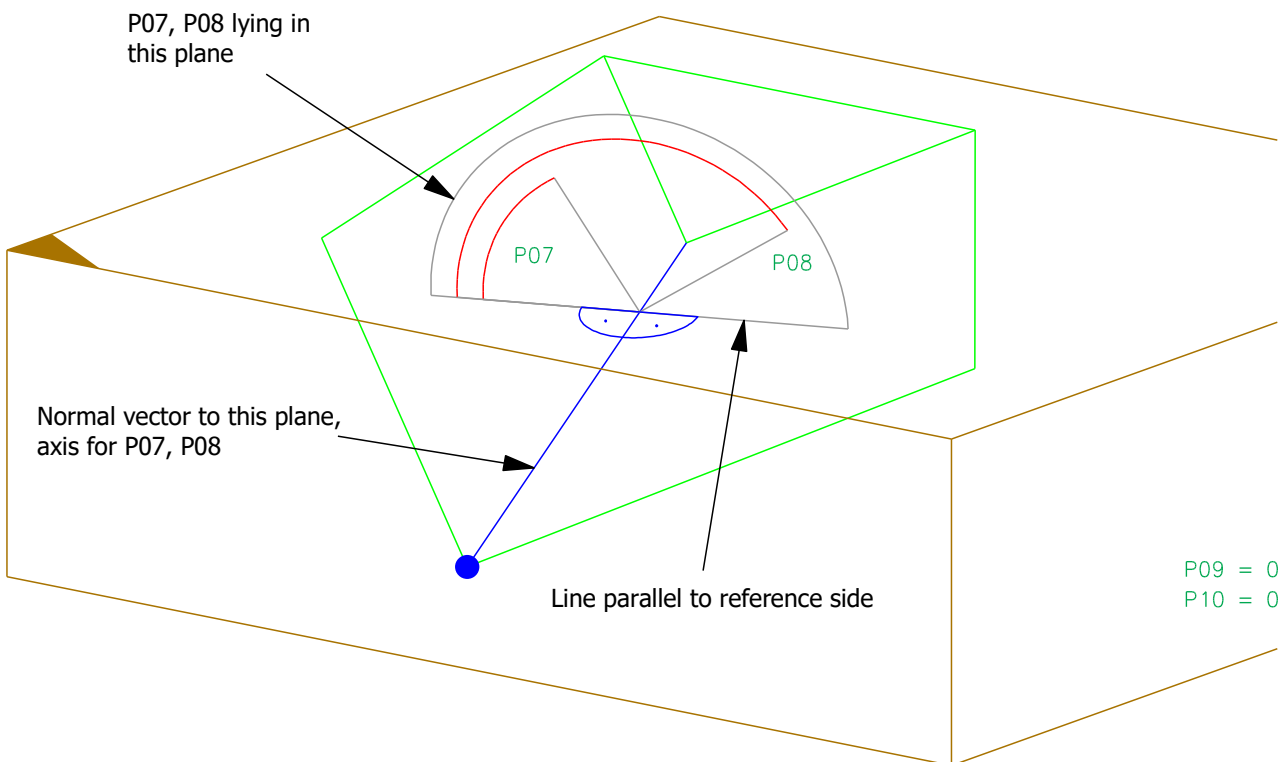

4-020-X P09 > 0 Another presentation of parameters

View orthogonal to face "P07"

The counterpart enters at the reference edge.

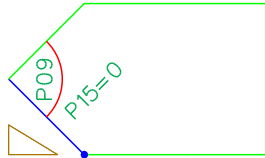

The counterpart enters at opposite of the reference edge.

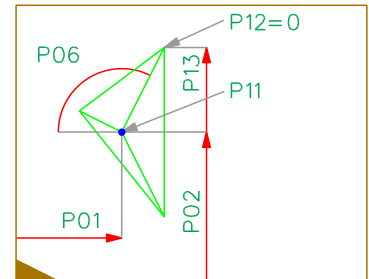
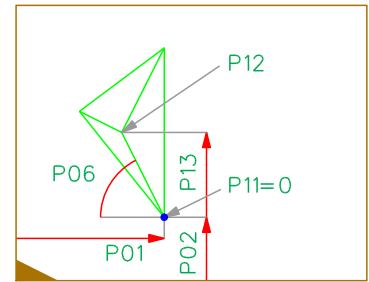
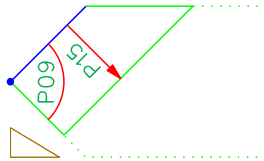
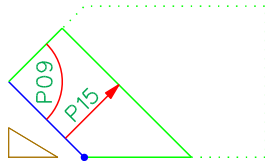
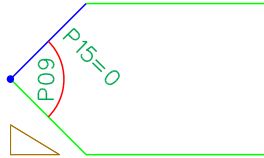

3-020-X P09 > 0 Another presentation of parameters

View orthogonal to face "P07"

The counterpart enters at the reference edge.

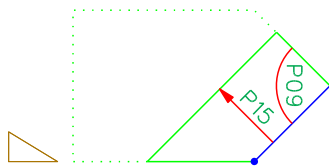

The counterpart enters at opposite of the reference edge.

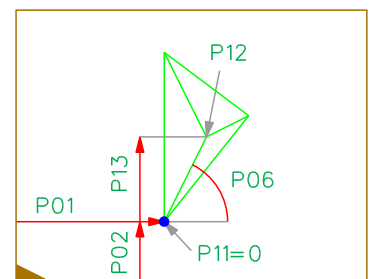
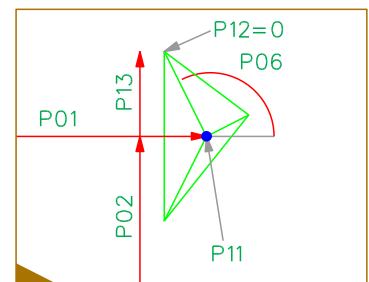
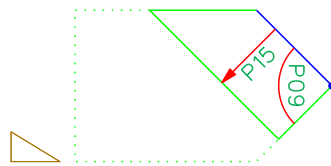

Parameters Birds Mouth

3-020-X and 4-020-X

Parameter	Min/Max	Presetting	Description
P01	+/- 99999	0	Distance from beam start to the reference point
P02	+/- 50000	0	Distance from the reference edge to the reference point
P04	-1/12	-1	Location of P09/P10, if P09>0 and P10>0 If P04=-1, then the location must be defined on the machineside.
P05	0/1	0	P05=1: drillhole for rafter nail, P05=0: no drillhole The machineside defines place and direction of the drillhole.
P06	1/179	90	Angle to the reference edge in the reference area
P07	0/180	45	Inclination between face 1 and reference side
P08	0/180	135	Inclination between face 2 and reference side
P09	0/179	0	First cut angle of the counterpart If P09 is zero, the limit face beside face 1 is parallel to component side.
P10	0/179	0	First cut inclination of the counterpart If P10 is zero, the limit face beside face 1 is parallel to component side.
P11	0/50000	20	Depth 1 orthogonal to reference side
P12	0/50000	20	Depth 2 orthogonal to reference side
P13	0/50000	0	Grooving depth in the transverse direction of the component If P13 is zero, then its value must be calculated: $P13=WRS-P02$
P14	0/50000	0	Height Counterpart. Zero means: no limit. Measurement orthogonal to face 1 (P07).
P15	0/50000	0	Width Counterpart. Zero means: no limit. Measurement orthogonal to face 2 (P08).

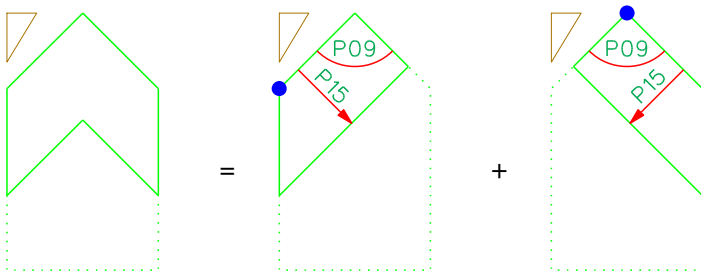

This kind of notch must be described with two notches.

Hip or Valley Rafter Notch 3-025-X and 4-025-X

4-025-X

hip rafter

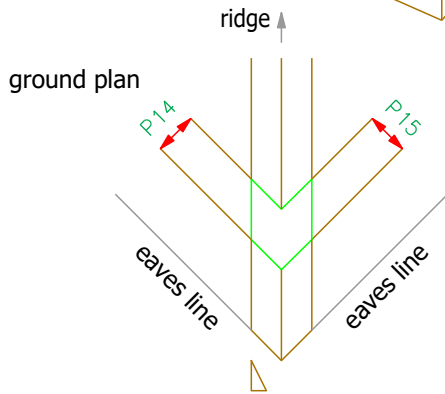
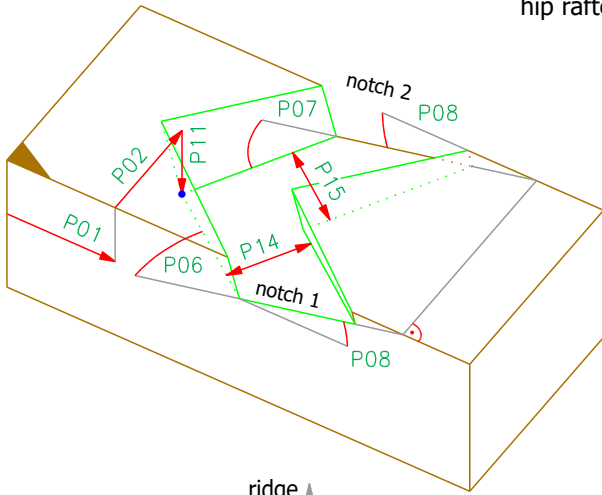

3-025-X

hip rafter

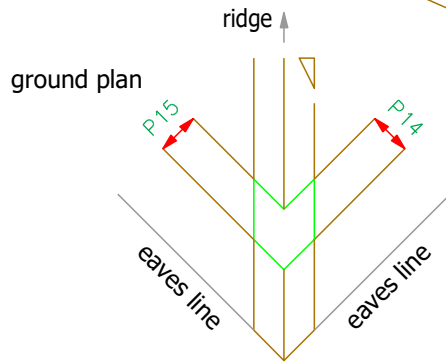
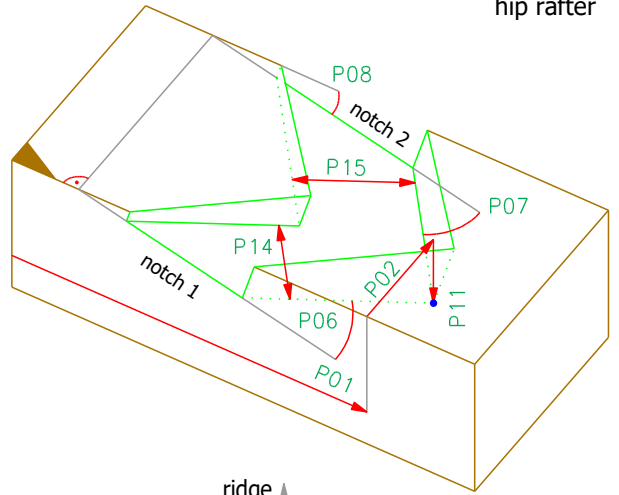

valley rafter

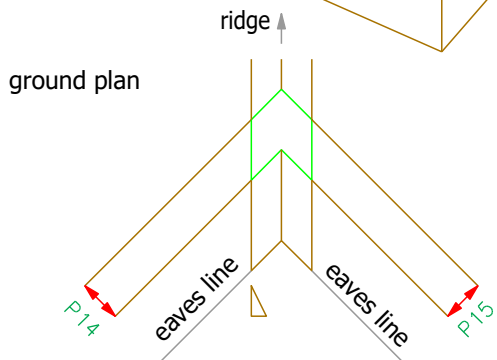
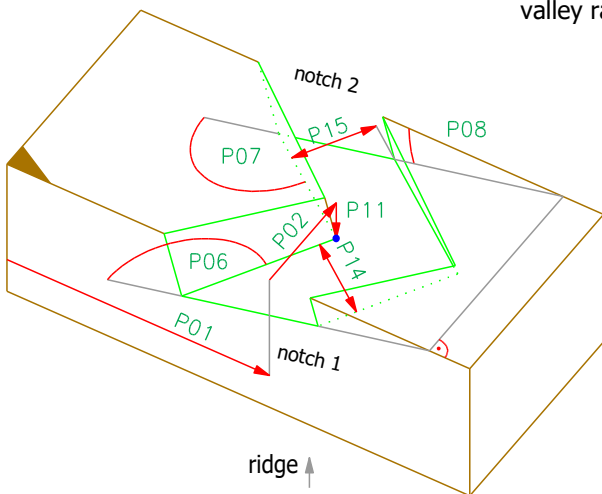

valley rafter

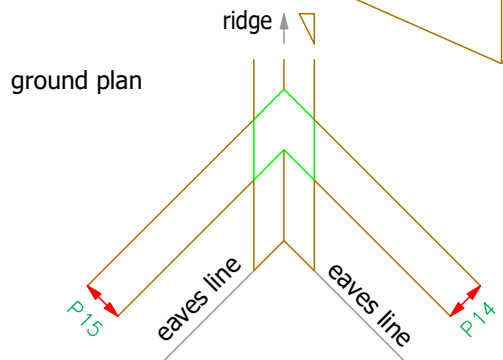
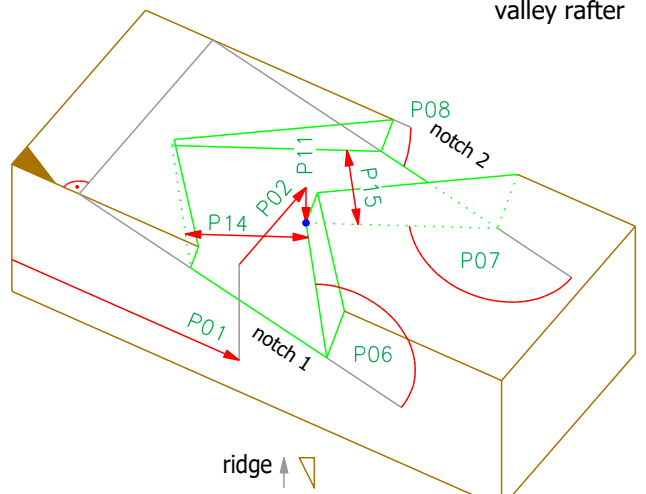

Parameters Hip or Valley Rafter Notch

3-025-X and 4-025-X

Parameter	Min/Max	Presetting	Description
P01	+/- 99999	0	Distance from beam start to the reference point
P02	+/- 50000	0	Distance from the reference edge to the reference point
P05	0/1	0	P05=1: drillhole for rafter nail, P05=0: no drillhole The machineside defines place and direction of the drillhole.
P06	1/179	45	Angle notch 1 to the reference edge in the reference area
P07	1/179	45	Angle notch 2 to the opposite reference edge in the reference area
P08	0/180	30	Inclination between base area of notches and reference side
P11	0/50000	20	Depth orthogonal to reference side
P14	0/50000	0	Width of notch 1. If this value is equal 0, then the notch is not limited.
P15	0/50000	0	Width of notch 2. If this value is equal 0, then the notch is not limited.

Ridge Lap 1-030-X und 2-030-x

2-030-X
P02 = 0

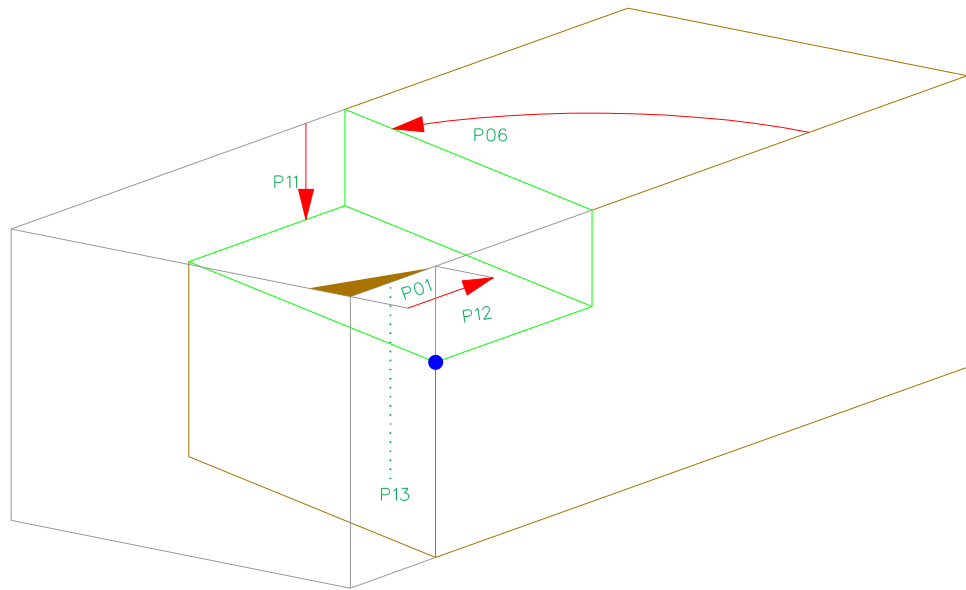

1-030-X
P02 = 0

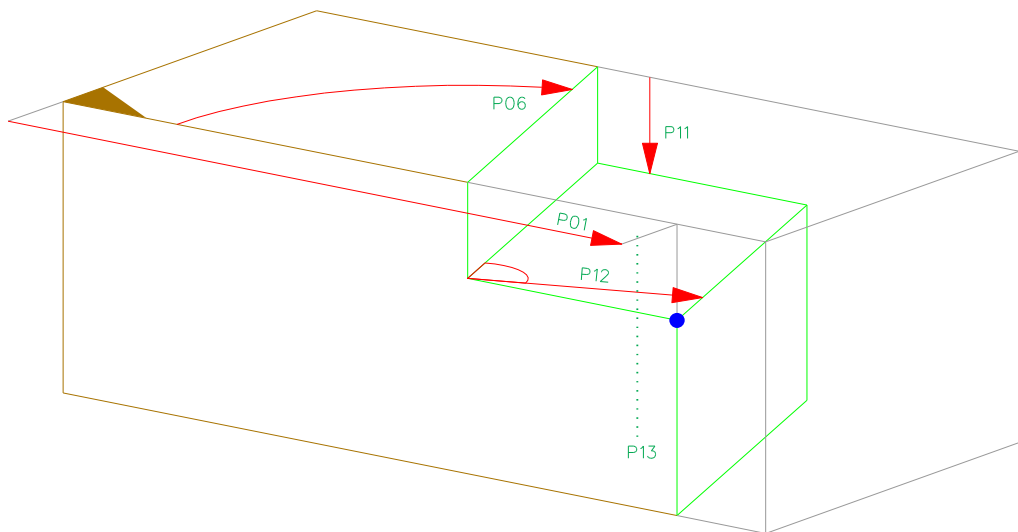

2-030-X
P02 = 1

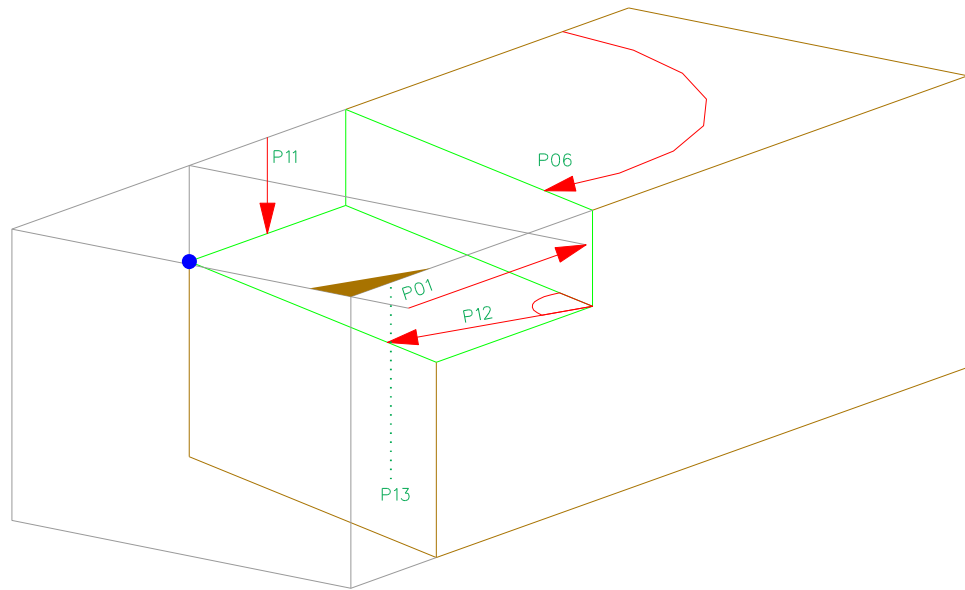

1-030-X
P02 = 1

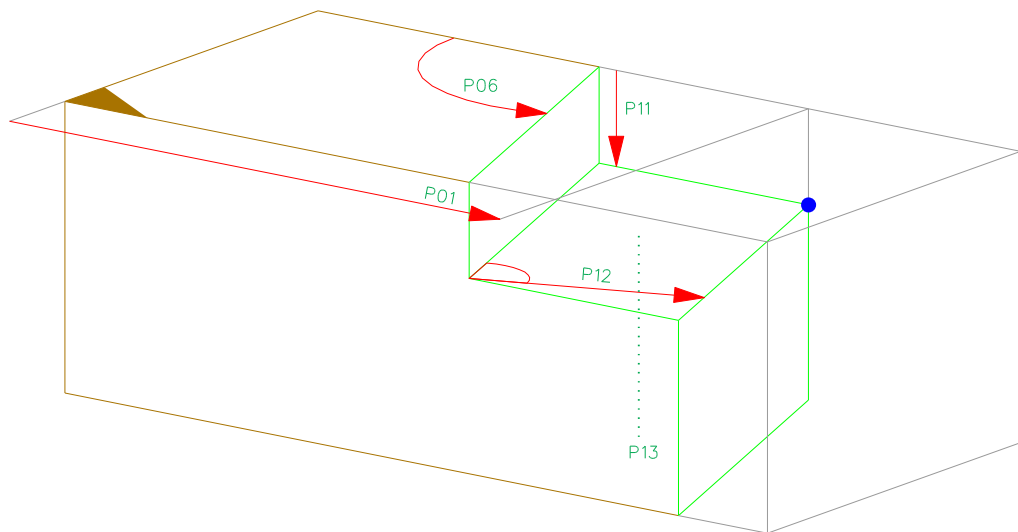

Parameters Ridge Lap

1-030-X and 2-030-X

Parameter	Min/Max	Presetting	Description
P01	+/- 99999	0	Distance from beam start to the reference point
P02	0/1	0	0: Reference point on referene edge 1: Reference point on the opposite edge
P06	1/179	90	Angle to the reference edge in the reference side
P11	1/50000	HRS/2	Depth of Half Lap
P12	1/50000	100	Width of Half Lap
P13	0/1000	0	Drill hole diameter

Lap Joint 3-030-X and 4-030-X

4-030-X

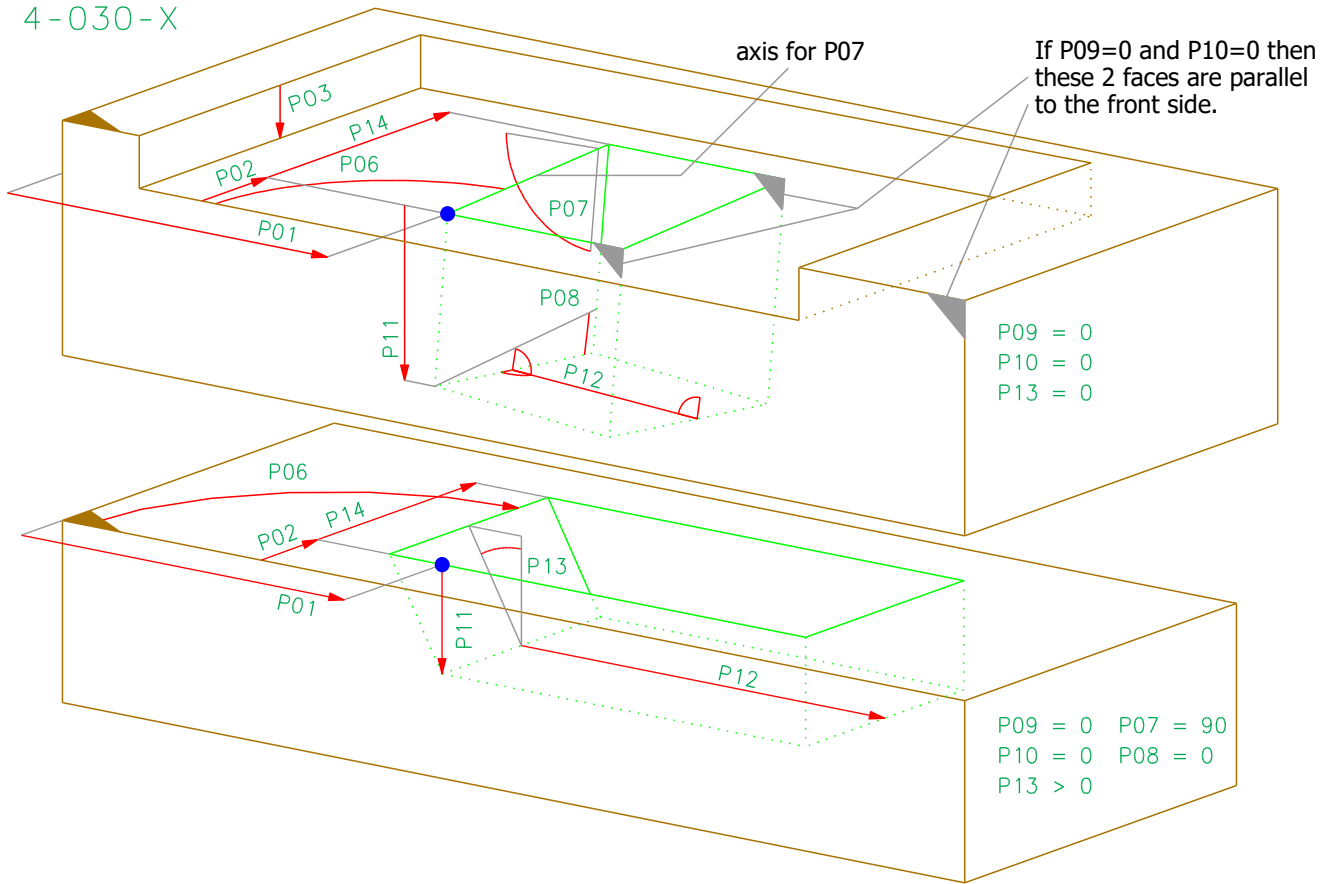

Location of P09/P10:

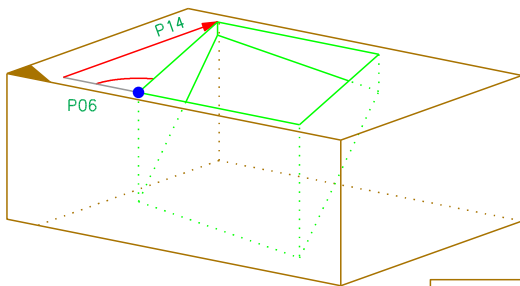

P09 = 0
P10 = 0

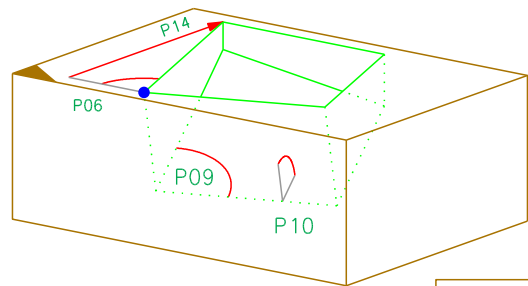
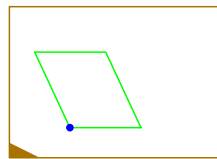

P09 > 0
P10 > 0

P04 = " __10__ "

Bit 3 = 0
Bit 4 = 1

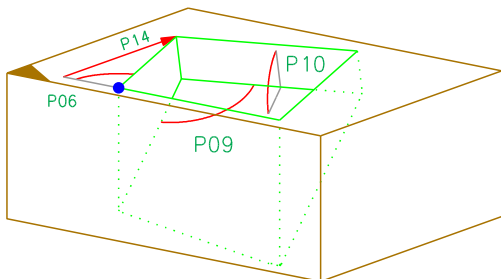
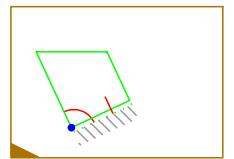

P09 > 0
P10 > 0

P04 = " __01__ "

Bit 3 = 1
Bit 4 = 0

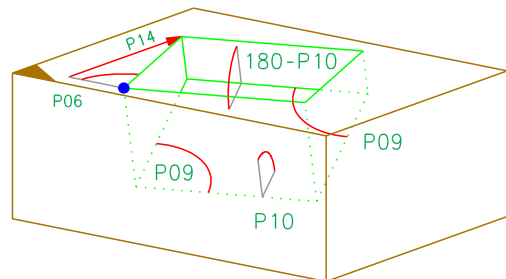
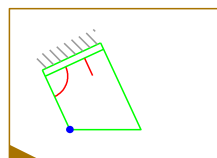

P09 > 0
P10 > 0

P04 = " __00__ "

Bit 3 = 0
Bit 4 = 0

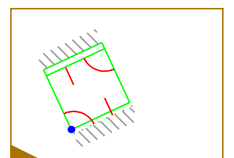

Parameters Lap Joint

3-030-X and 4-030-X

Parameter	Min/Max	Presetting	Description
P01	+/- 99999	0	Distance from beam start to the reference point
P02	+/- 50000	0	Distance from the reference edge to the reference point
P03	0/50000	0	Displacement to the reference side
P04	0/63	0	Limit of the 6 faces of the lap, binary code
P06	1/179	90	Angle to the reference edge in the reference side
P07	1/179	90	Inclination to the reference side
P08	-89/89	0	Angle between edge and reference side in face
P09	0/179	0	Angle in the floor face
P10	0/179	0	Angle between base face and one face of lap
P11	+/- 50000	HRS/2	Distance (orthogonal) from reference side to point below reference point
P12	1/99999	100	Length
P13	0/89	0	Chamfer angle
P14	0/50000	0	Grooving depth (length of the lapped scarf in transverse direction) If P14 is zero, then its value must be calculated: $P14=WRS-P02$

P04

This parameter describes, if the sides of lap are limited.
This description also applies to processings 016, 032 and 039.
A lap has six faces, so the information is described with binary code.

0=face is limited
1=face is open

P04 gives no information, on which edge (or which edges) of the referenceside the lap is coming out

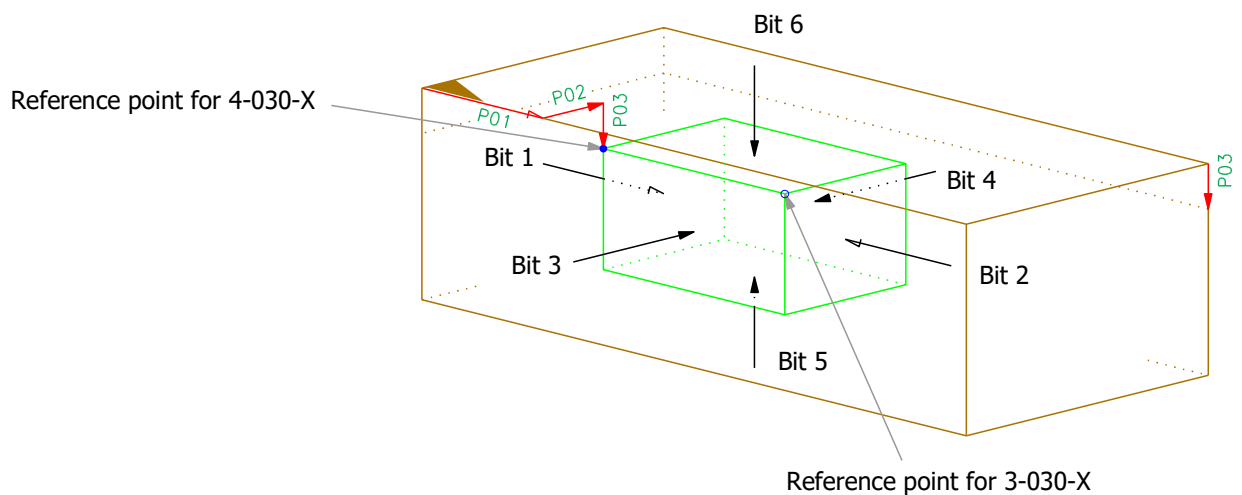

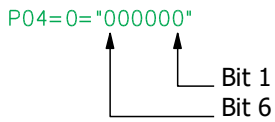

4-030-X

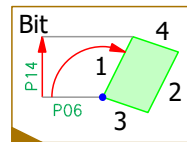

3-030-X

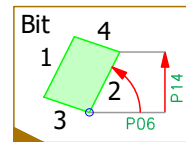

Bit 1 = $2^0 = 1$
 Bit 2 = $2^1 = 2$
 Bit 3 = $2^2 = 4$
 Bit 4 = $2^3 = 8$
 Bit 5 = $2^4 = 16$
 Bit 6 = $2^5 = 32$

P04=0="xx0000"

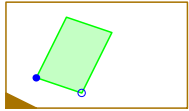

P04=1="xx0001"

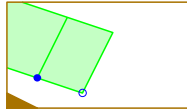

P04=2="xx0010"

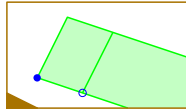

P04=3="xx0011"

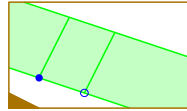

P04=4="xx0100"

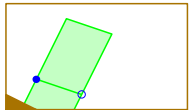

P04=5="xx0101"

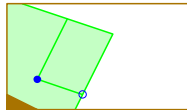

P04=6="xx0110"

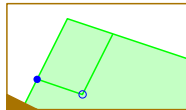

P04=7="xx0111"

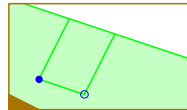

P04=8="xx1000"

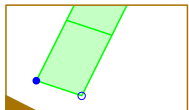

P04=9="xx1001"

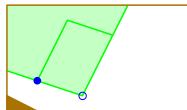

P04=10="xx1010"

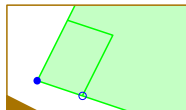

P04=11="xx1011"

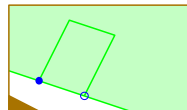

P04=12="xx1100"

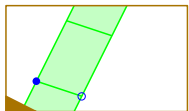

P04=13="xx1101"

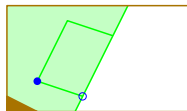

P04=14="xx1110"

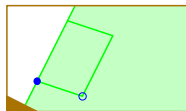

P04=15="xx1111"

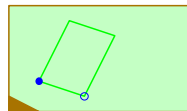

P04="00xxxx"

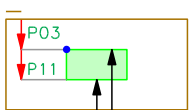

P04="01xxxx"

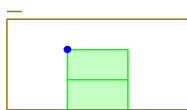

P04="10xxxx"

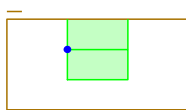

P04="11xxxx"

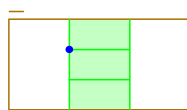

Bit 6 (Top of lap)
Bit 5 (Bottom of lap)

P09 / P10

Description, how P09/P10 influences the side-faces of the lap.

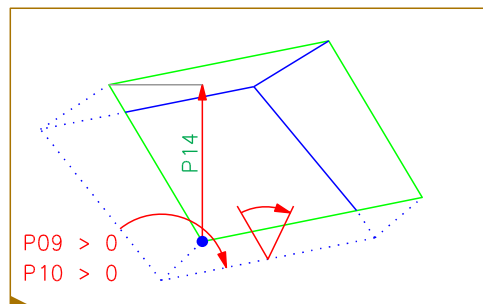
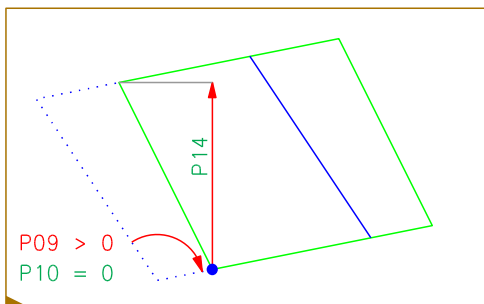
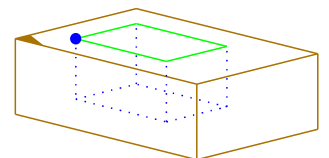
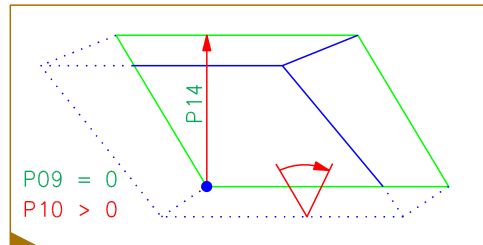
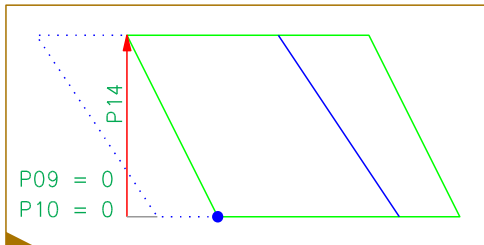

Notch/Rabbet 3-032-X and 4-032-X

4-032-X

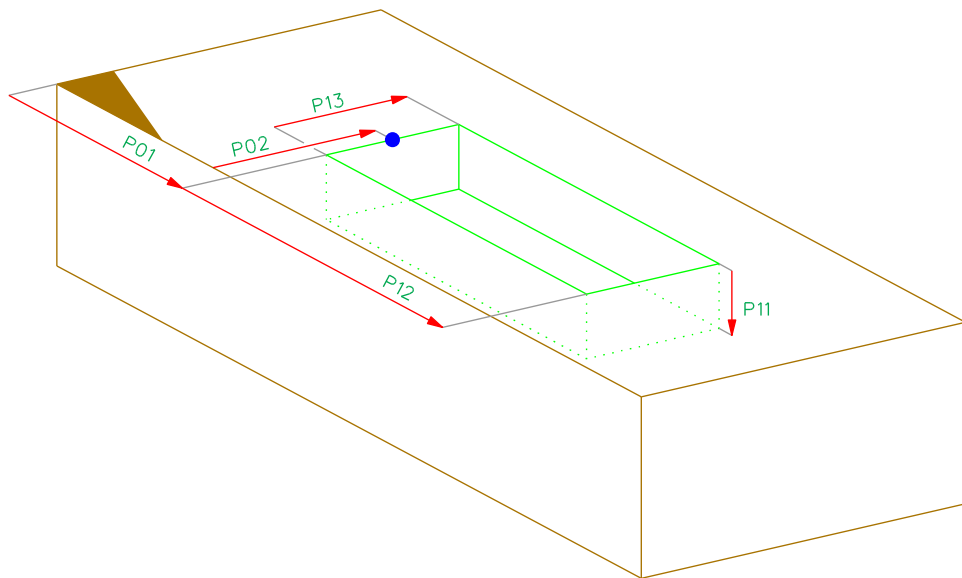

3-032-X

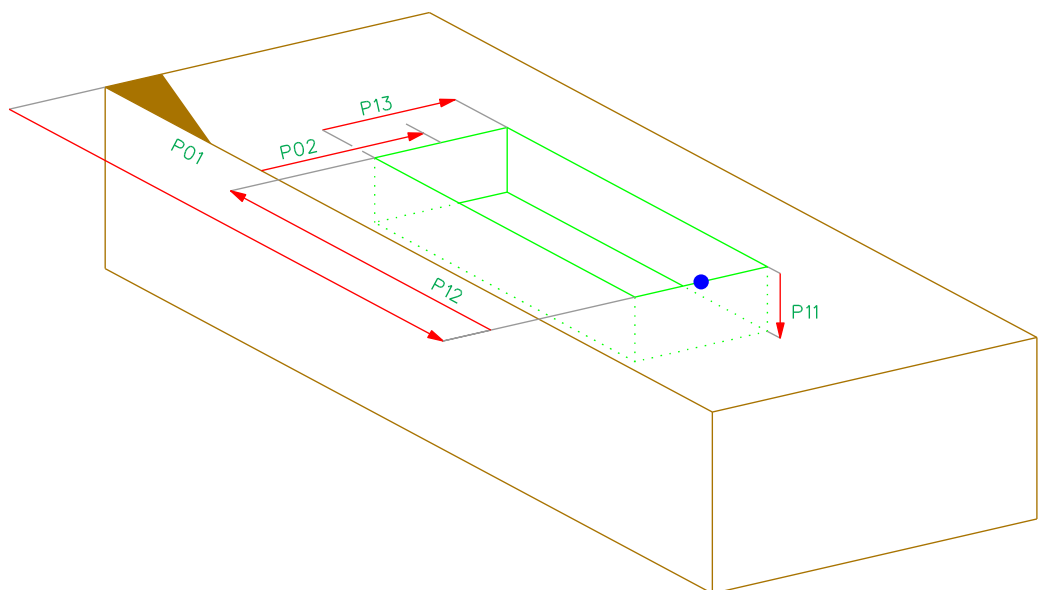

Parameters Notch/Rabbet

3-032-X und 4-032-X

Parameter	Min/Max	Presetting	Description
P01	+/- 99999	0	Distance from beam start to the reference point
P02	+/- 50000	0	Distance from the reference edge to the reference point
P04	0/63	0	Limit of the 6 faces of the notch/rabbet, binary code
P11	0/50000	20	Notch/Rabbet depth
P12	0/99999	20	Notch/Rabbet length
P13	1/50000	200	Notch/Rabbet width

P04=0="000000"

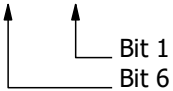

4-032-X

3-032-X

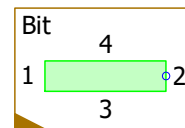
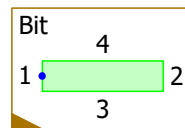

- Bit 1 = $2^0 = 1$
- Bit 2 = $2^1 = 2$
- Bit 3 = $2^2 = 4$
- Bit 4 = $2^3 = 8$
- Bit 5 = $2^4 = 16$
- Bit 6 = $2^5 = 32$

P04=0="xx0000"

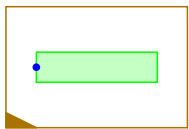

P04=1="xx0001"

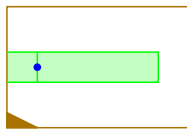

P04=2="xx0010"

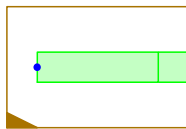

P04=3="xx0011"

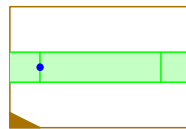

P04=4="xx0100"

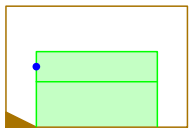

P04=5="xx0101"

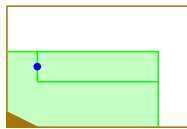

P04=6="xx0110"

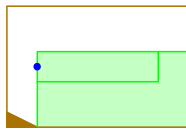

P04=7="xx0111"

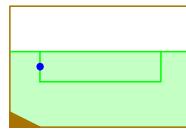

P04=8="xx1000"

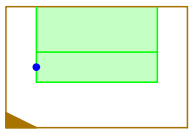

P04=9="xx1001"

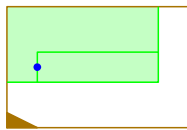

P04=10="xx1010"

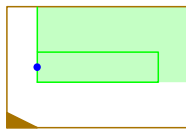

P04=11="xx1011"

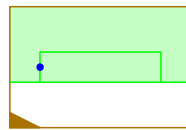

P04=12="xx1100"

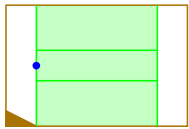

P04=13="xx1101"

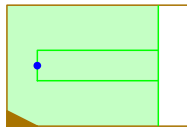

P04=14="xx1110"

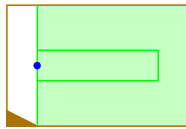

P04=15="xx1111"

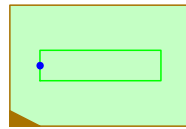

P04="00xxxx"

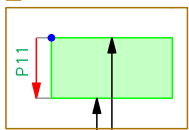

P04="01xxxx"

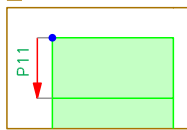

P04="10xxxx"

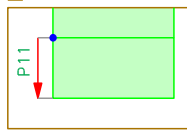

P11="11xxxx"

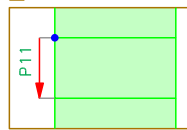

Bit 6 (Enter edge of notch)
Bit 5 (Bottom of notch)

Block House Half Lap, Stair Riser Dado 3-033-X and 4-033-X

4-033-X

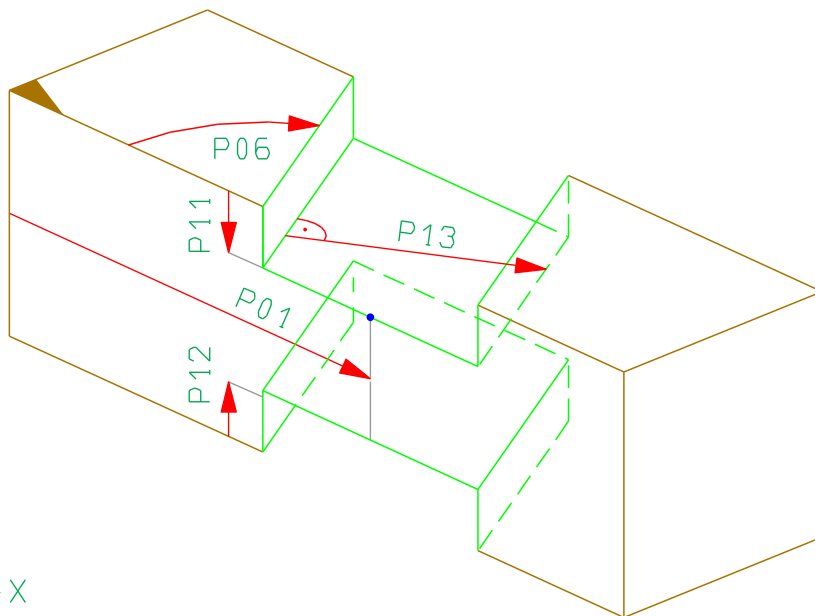

3-033-X

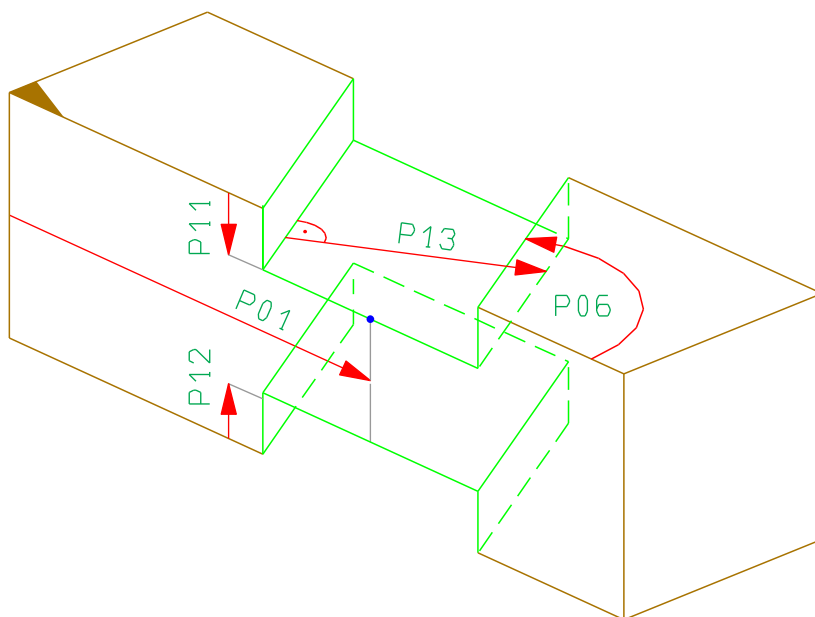

Parameters Block House Half Lap, Stair Riser Dado

3-033-X and 4-033-X

Parameter	Min/Max	Presetting	Description
P01	+/- 99999	0	Distance from beam start to the reference point
P06	1/179	90	Angle between cut edge and reference edge
P11	0/HRS	20	Depth of the Half Lap on the reference side
P12	0/HRS	20	Depth of the Half Lap opposite of the reference side
P13	1/50000	WRS	Length of the Half Lap / Dado

Seathing Cut 3-034-X and 4-034-X

4-034-X

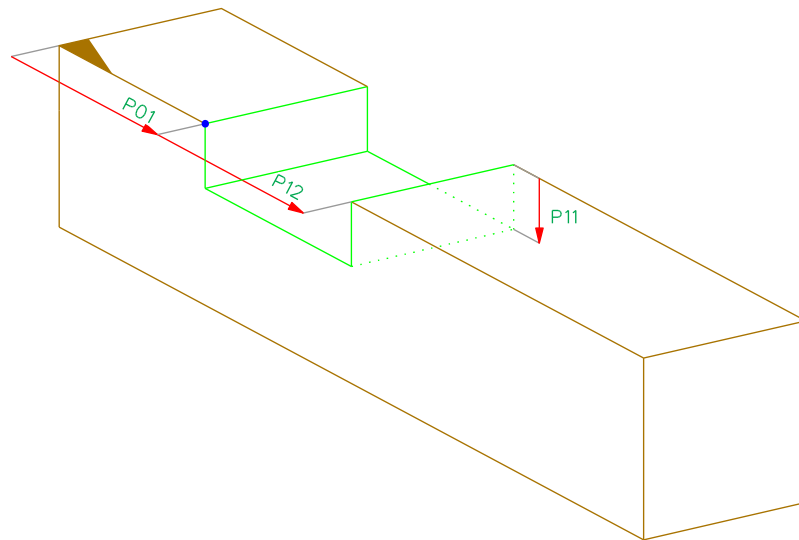

3-034-X

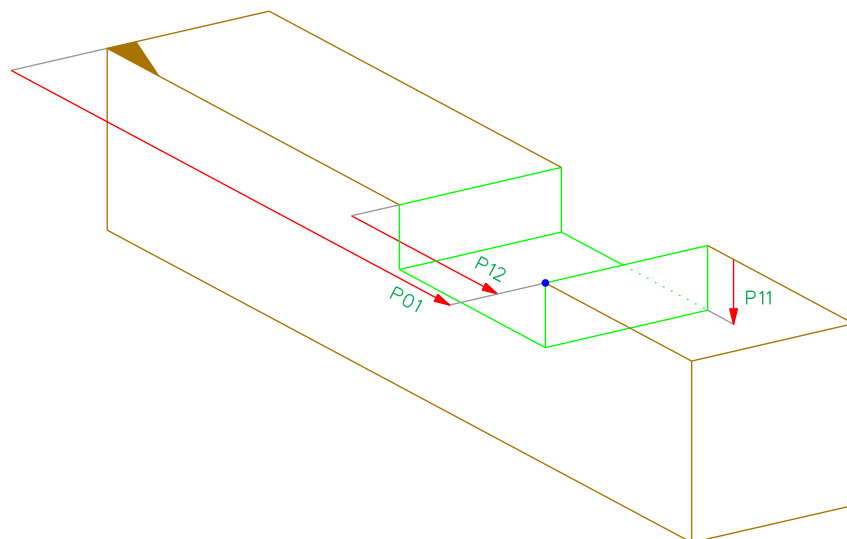

Parameters Seathing Cut

3-034-X and 4-034-X

Parameter	Min/Max	Presetting	Description
P01	+/- 99999	0	Distance from beam start to the reference point
P11	0/HRS	1	Depth of Seathing Cut
P12	1/99999	LRS	Length of Seathing Cut

French Ridge Lap 1-035-X and 2-035-X

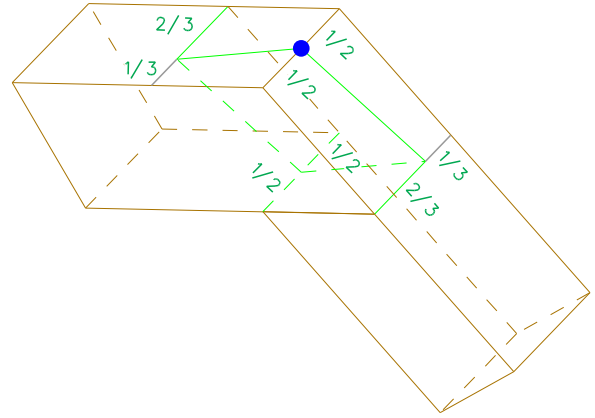
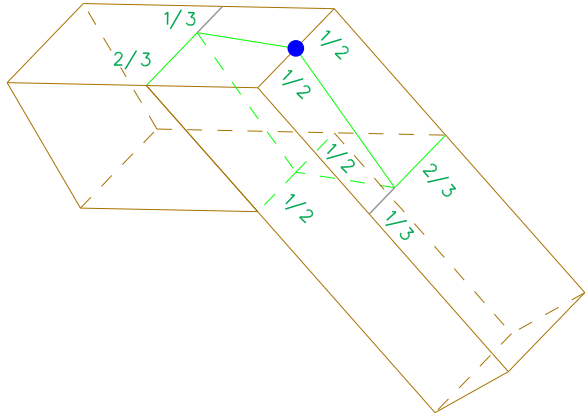

The length of the lap is equal to the width of reference side.

2-035-X

P02=0

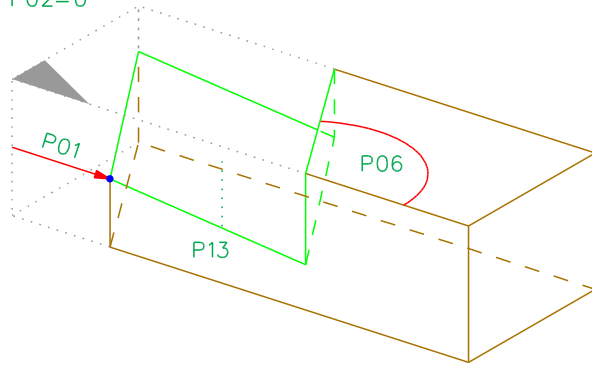

2-035-X

P02=1

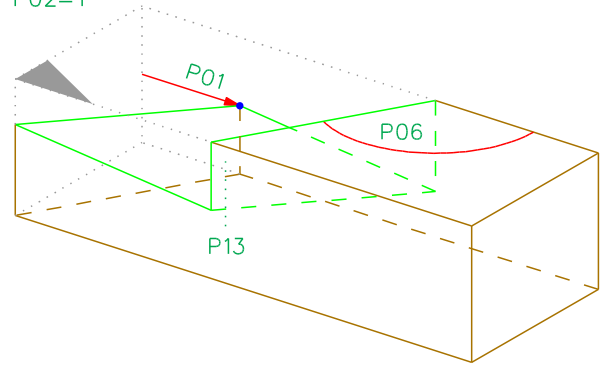

1-035-X

P02=1

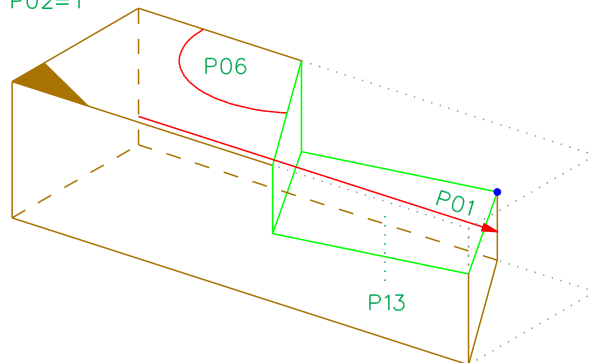

1-035-X

P02=0

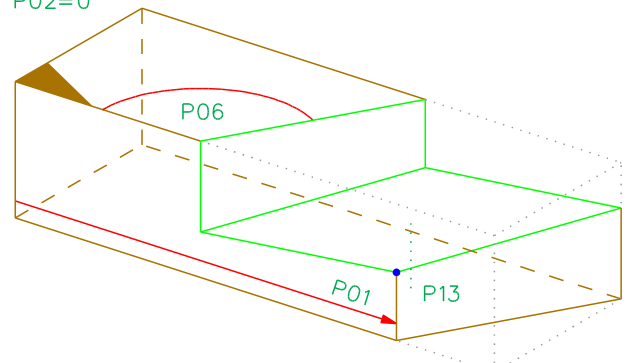

Parameters French Ridge Lap

1-035-X and 2-035-X

Parameter	Min/Max	Presetting	Description
P01	+/- 99999	0	Distance from beam start to the reference point
P02	0/1	0	0: Reference point on reference edge 1: Reference point on the opposite edge
P06	1/179	90	Angle to the reference edge in the reference side
P13	0/1000	0	Drill hole diameter

Chamfer 3-036-X and 4-036-X

4-036-X

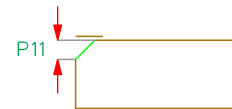
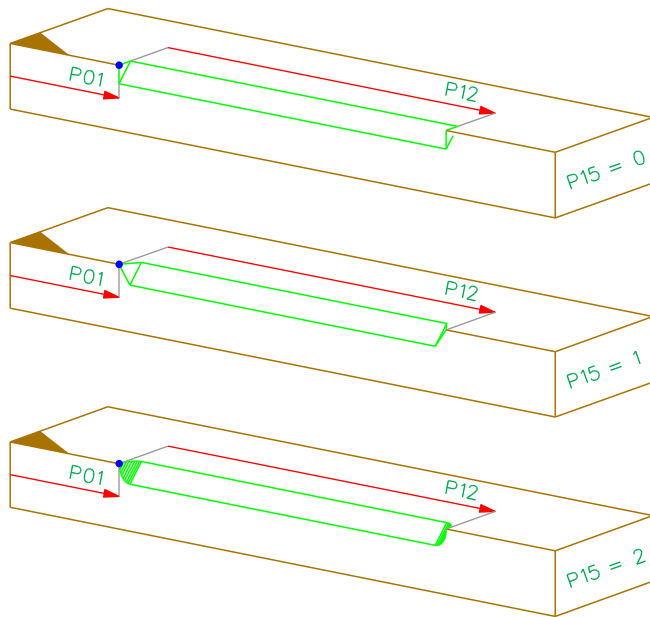

3-036-X

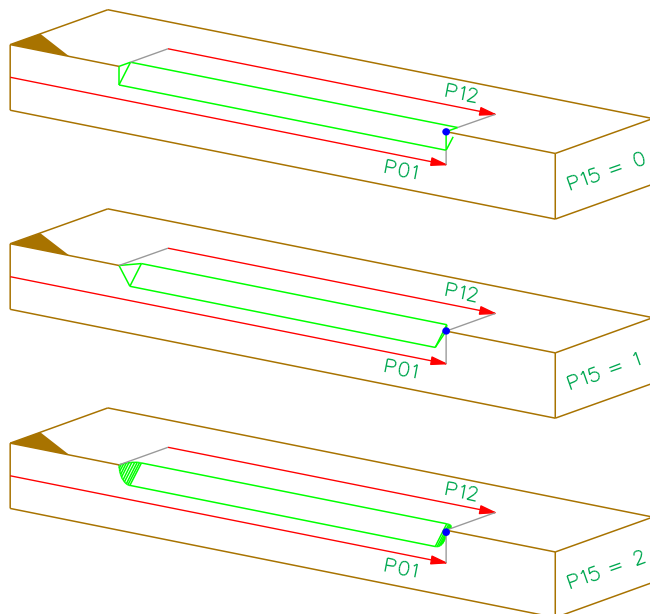

Parameters Chamfer

3-036-X and 4-036-X

Parameter	Min/Max	Presetting	Description
P01	+/- 99999	0	Distance from beam start to the reference point
P04		1	Input of edge(s) to be beveled, binary code: Bit 0=edge 1 ; Bit 1=edge 2; Bit 2=edge 3; Bit 3=edge 4 Example: P04=9: edge 1+4; P04=3: edge 1+2
P11	1/HRS	1	Depth
P12	0/99999	LRS	Length If P12 is equal to zero, the processing is performed along the whole component length.
P15	0,1,2	0	Shape for bevel exit: 0 = orthogonal, 1 = at 45 deg, 2 = round;

Block House Half Lap 4-037-X

P04 = 0

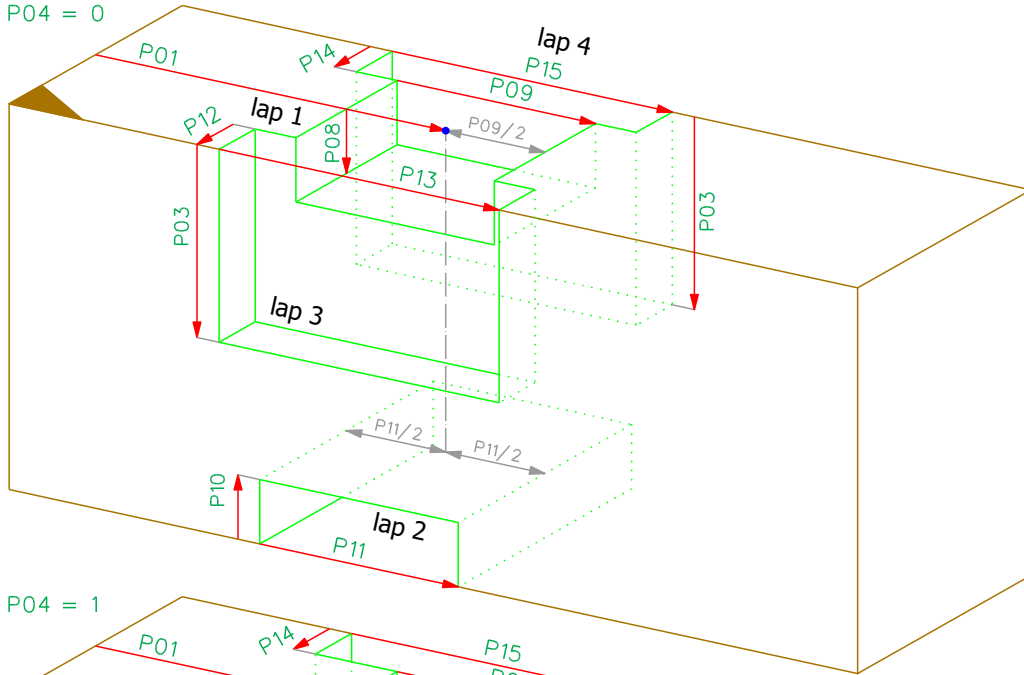

P04 = 1

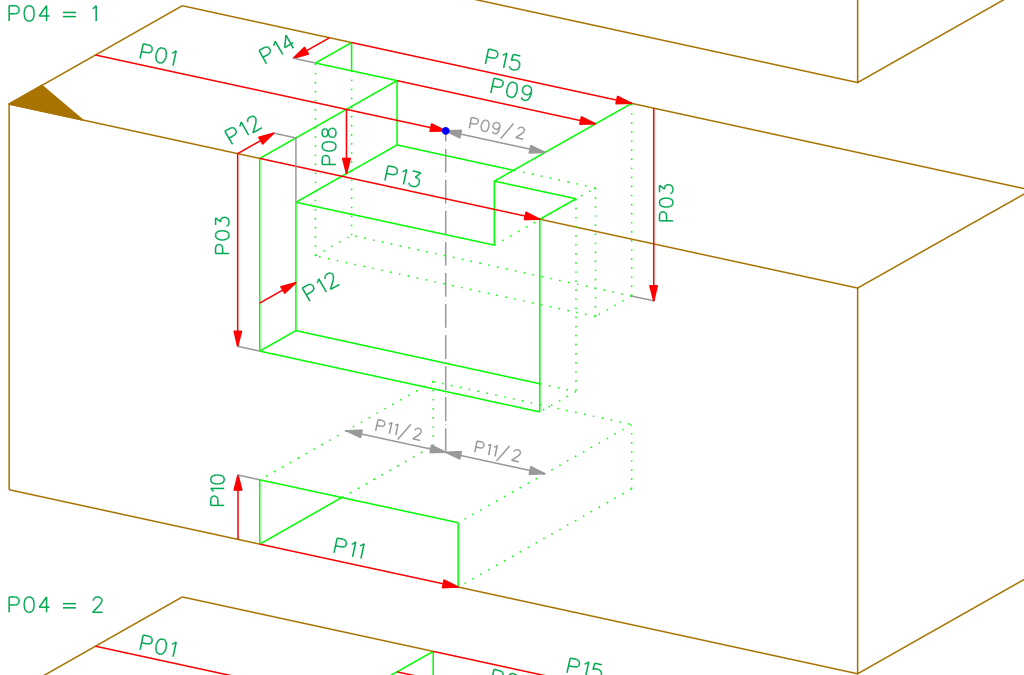

P04 = 2

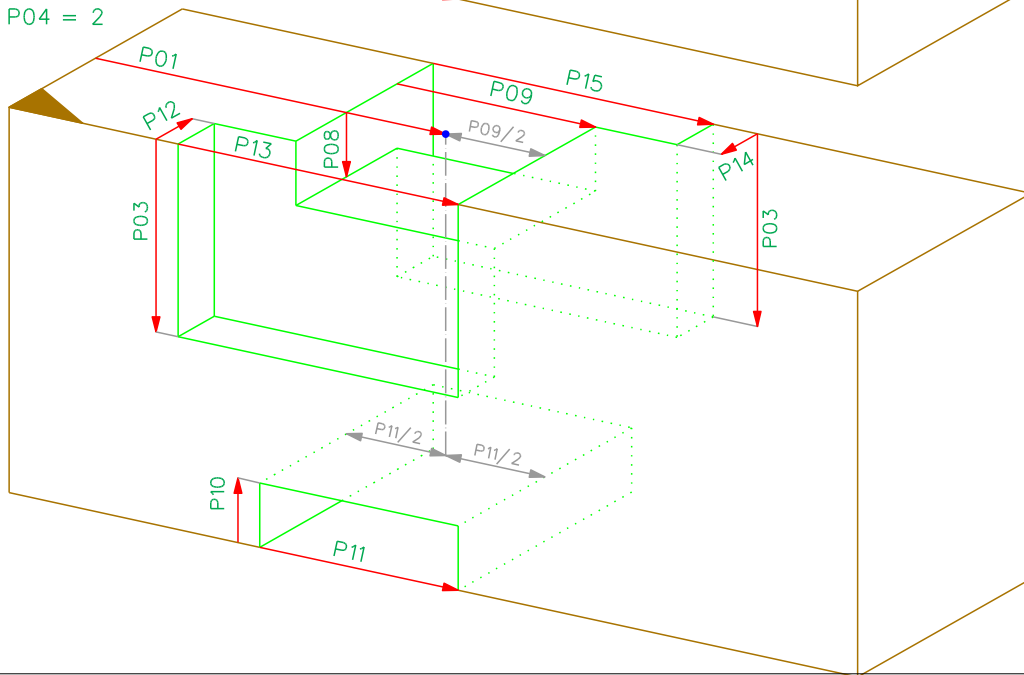

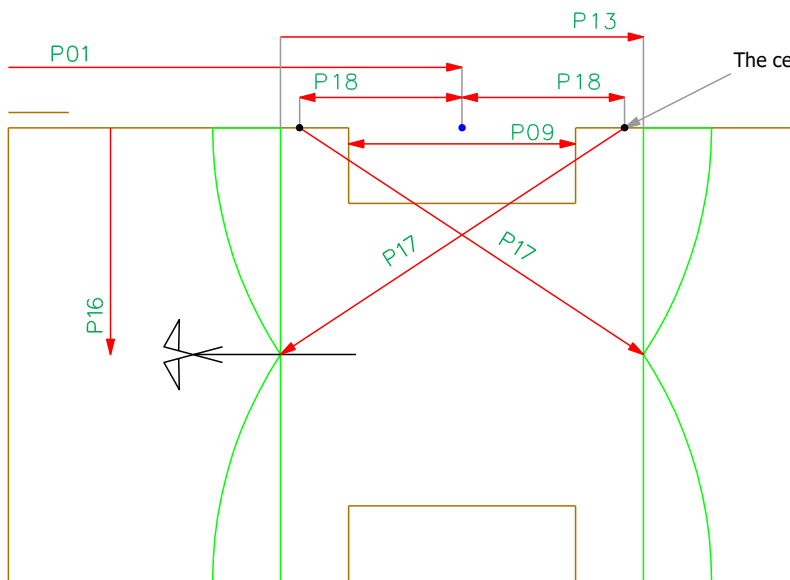
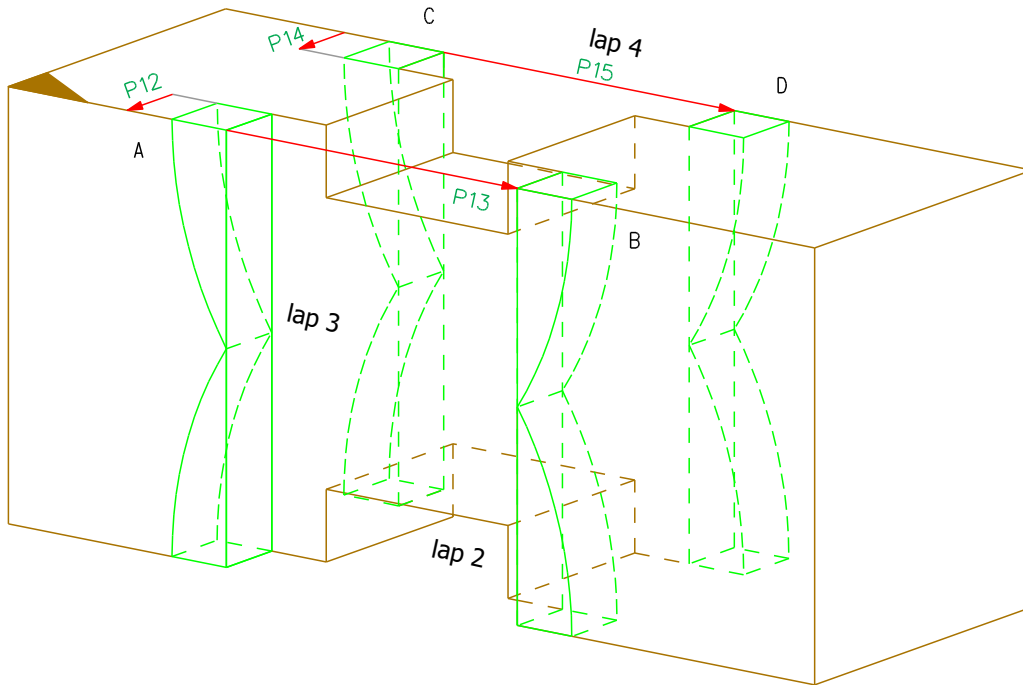

P19	A	B	C	D
0	0	0	0	0
1	0	0	0	1
2	0	0	1	0
3	0	0	1	1
4	0	1	0	0
5	0	1	0	1
6	0	1	1	0
7	0	1	1	1
8	1	0	0	0
9	1	0	0	1
10	1	0	1	0
11	1	0	1	1
12	1	1	0	0
13	1	1	0	1
14	1	1	1	0
15	1	1	1	1

Parameters Block House Half Lap

4-037-X

Parameter	Min/Max	Presetting	Description
P01	+/- 99999	0	Distance from beam start to the reference point
P03		0	Depth orthogonal to reference side of the lap 2 and 4. If P03 is zero, then its value must be calculated: $P03=HRS$
P04		0	0: all laps are symmetric to each other 1: lap on reference edge moved to end beam lap in opposite of reference edge moved to start beam 2: lap on reference edge moved to start beam lap in opposite of reference edge moved to end beam
P05	0/1	0	P05=1: drillhole for drop rod, P05=0: no drillhole The machines defines place and direction of the drillhole.
P08	0/50000	10	lap 1: Depth
P09	0/50000	100	lap 1: Length
P10	0/50000	10	lap 2: Depth
P11	0/50000	100	lap 2: Length
P12	0/50000	10	lap 3: Depth
P13	0/50000	100	lap 3: Length
P14	0/50000	10	lap 4: Depth
P15	0/50000	100	lap 4: Length
P16	0/50000	HRS/2	Distance from end of arc orthogonal to the reference side
P17	0/50000	HRS	Radius of arc
P18	0/50000	HRS	Distance reference point to center of arc
P19	0/15	0	Which arc (A, B,C or D) is to produced, binary code

Block House Front 3-038-X and 4-038-X

4-038-X

P04=1

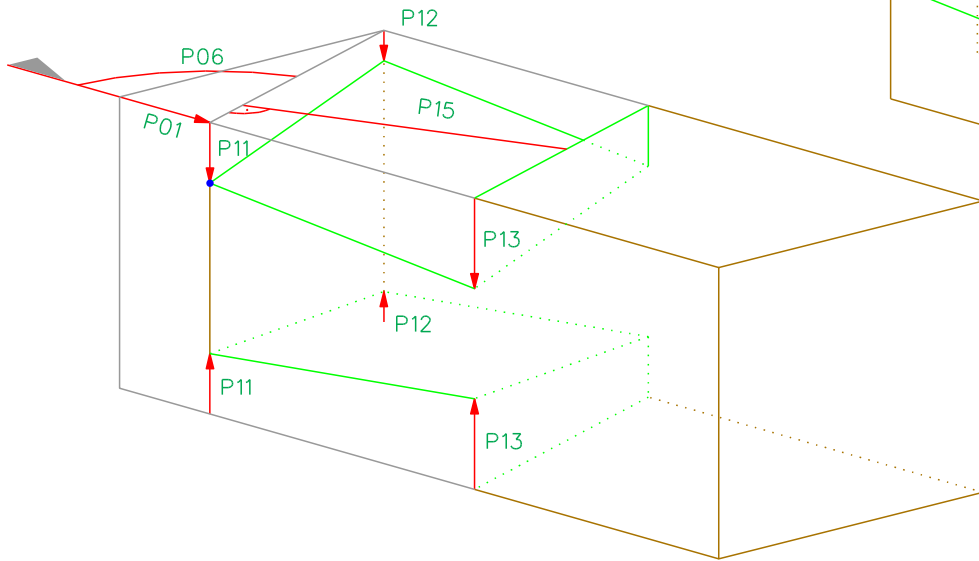

P04=0

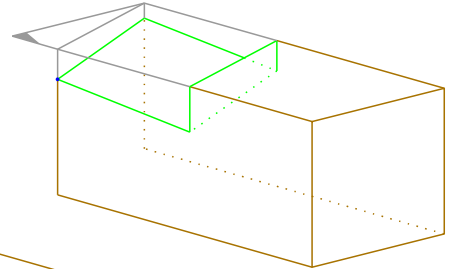

3-038-X

P04=1

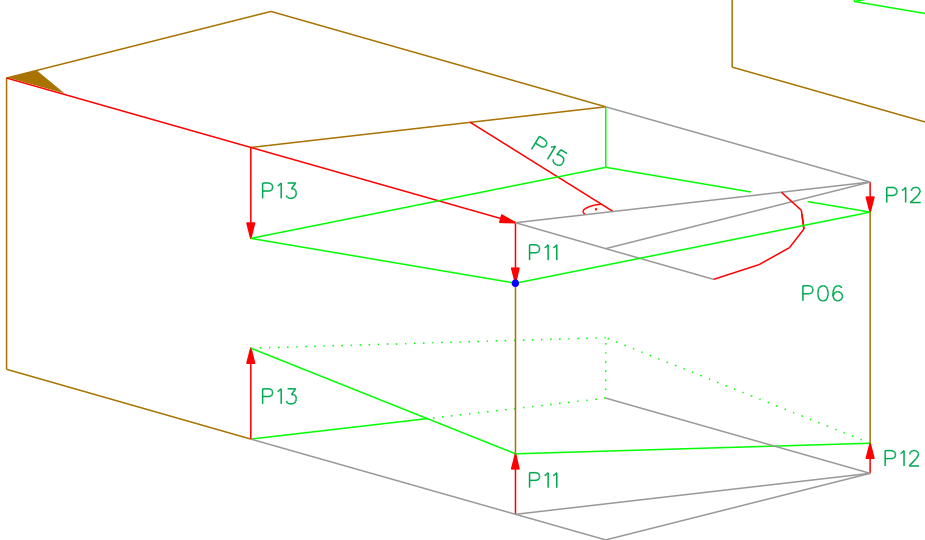

P04=0

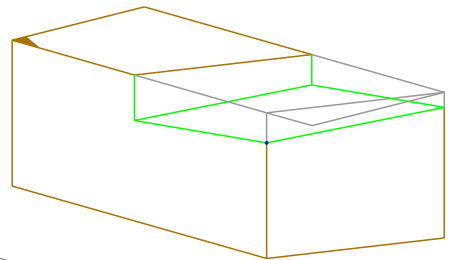

Parameters Block House Front

3-038-X and 4-038-X

Parameter	Min/Max	Presetting	Description
P01	+/- 99999	0	Distance from beam start to the reference point
P04	0/1	0	0: only one lap on reference side 1: one lap on reference side and one on the opposite side
P06	1/179	90	Angle to the reference edge in the reference side
P11	+/- 50000	15	Depth at reference point
P12	+/- 50000	10	Depth opposite to the reference point
P13	+/- 50000	25	Depth at reference edge
P15	0/50000	100	Length

Pocket 4-039-X

4-039-X

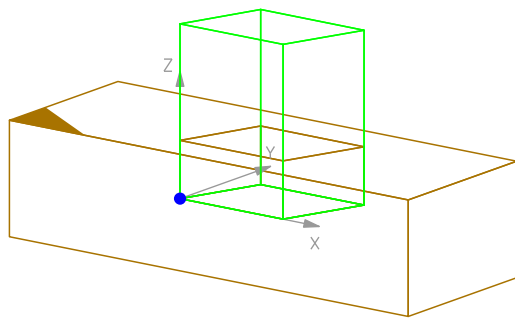
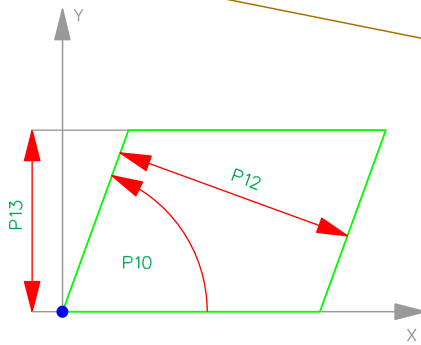
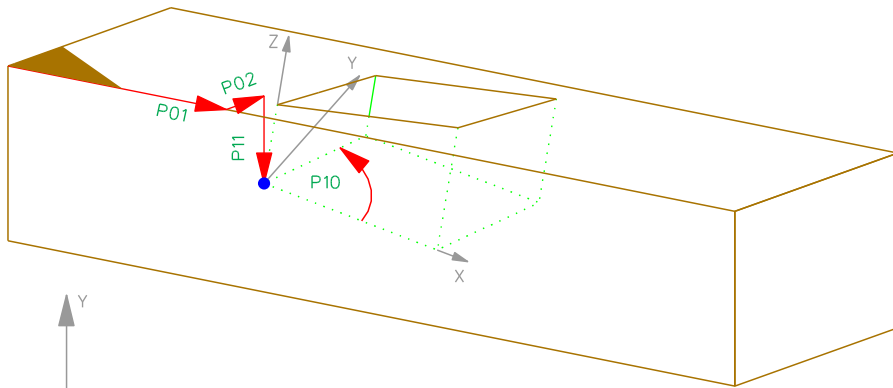

==>

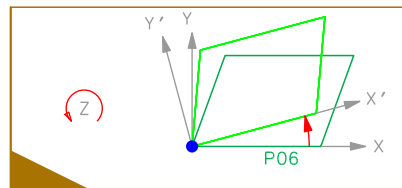

==>

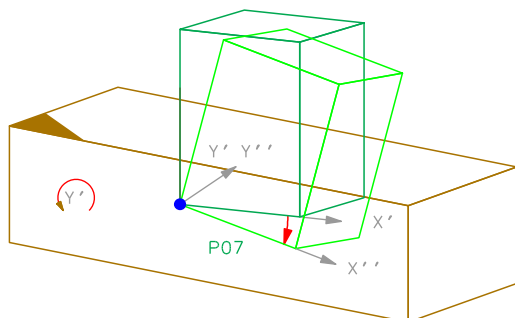

==>

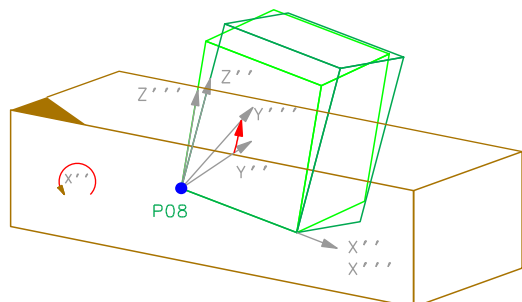

Parameters Pocket

4-039-X

Parameter	Min/Max	Presetting	Description
P01	+/- 99999	0	Distance from beam start to the reference point
P02	+/- 50000	0	Distance from the reference edge to the reference point
P04	0/63	0	Limit of the 6 faces of the pocket, binary code
P06	-179/179	0	Rotation angle around the local z-axis of the cuboid
P07	-179/179	0	Rotation angle around the local y-axis of the cuboid, rotated with P06
P08	-179/179	0	Rotation angle around the local x-axis of the cuboid, rotated with P06 and P07
P10	1/179	0	Internal angle at the reference point
P11	+/- 50000	20	Depth of reference point orthogonal to reference side
P12	1/50000	20	Length of Half Lap
P13	0/50000	100	Width of Half Lap

P04

P04=0="xx0000"

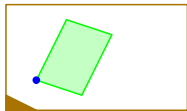

P04=1="xx0001"

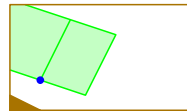

P04=2="xx0010"

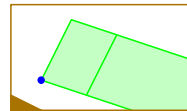

P04=3="xx0011"

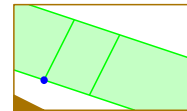

P04=0="000000"

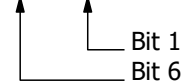

P04=4="xx0100"

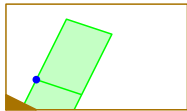

P04=5="xx0101"

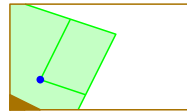

P04=6="xx0110"

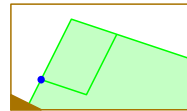

P04=7="xx0111"

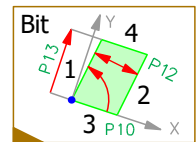
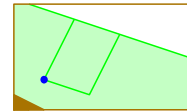

- Bit 1 = $2^0 = 1$
- Bit 2 = $2^1 = 2$
- Bit 3 = $2^2 = 4$
- Bit 4 = $2^3 = 8$
- Bit 5 = $2^4 = 16$
- Bit 6 = $2^5 = 32$

P04=8="xx1000"

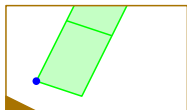

P04=9="xx1001"

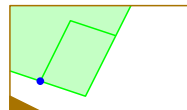

P04=10="xx1010"

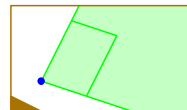

P04=11="xx1011"

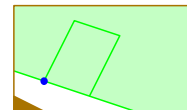

P04=12="xx1100"

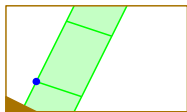

P04=13="xx1101"

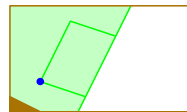

P04=14="xx1110"

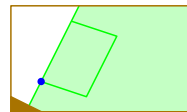

P04=15="xx1111"

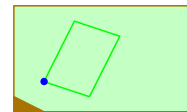

P04="00xxxx"

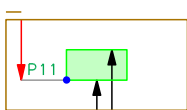

P04="01xxxx"

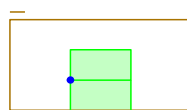

P04="10xxxx"

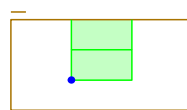

P04="11xxxx"

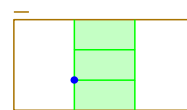

Bit 6 (Top of pocket)
Bit 5 (Bottom of pocket)

Drilling 3-040-X und 4-040-X

4-040-X
P03 = 0

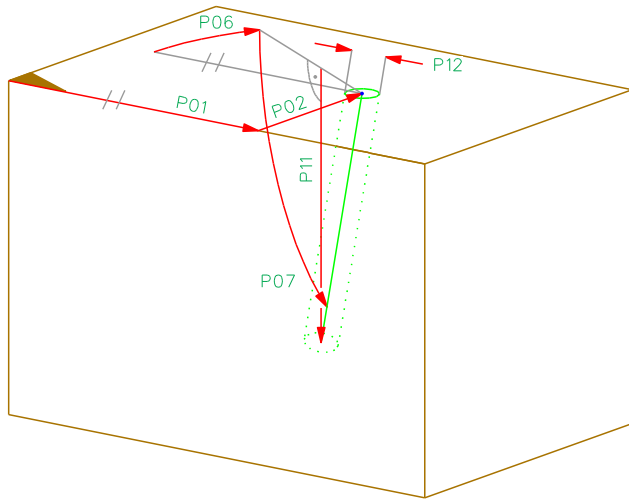

3-040-X
P03 = 0

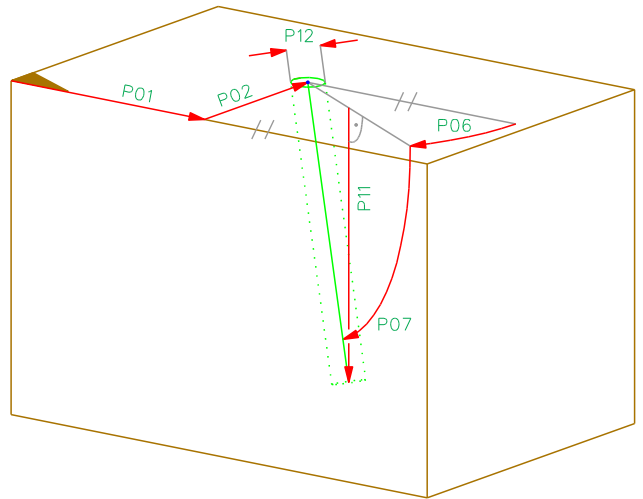

4-040-X
P03 <> 0

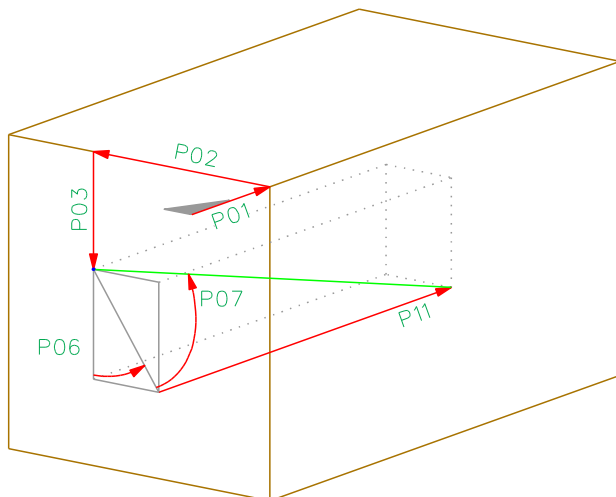

3-040-X
P03 <> 0

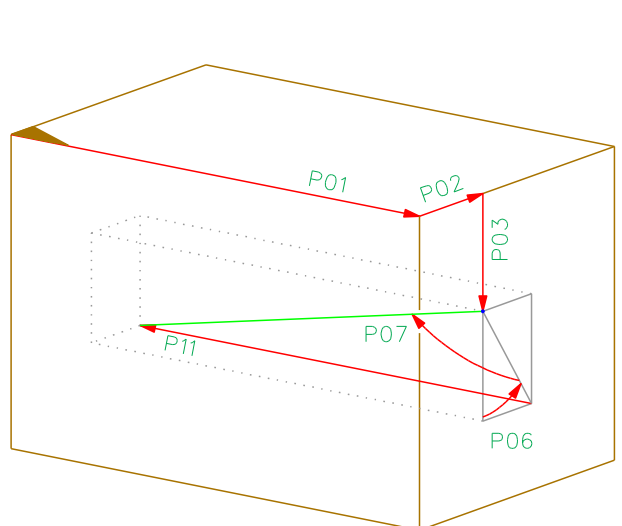

Parameters Drilling

3-040-X and 4-040-X

Parameter	Min/Max	Presetting	Description
P01	+/- 99999	0	Distance from beam start to the reference point
P02	+/- 50000	0	Distance from the reference edge to the reference point
P03	+/- 99999	0	Distance from the reference face to the reference point P03 = 0: Drilling on one of the 4 sides of the component. P03 <> 0: Drilling on one of the 2 front sides of the component
P06	0/360	90	P03 = 0: Angle to the reference edge in the reference side. P03 <> 0: Angle in the front side.
P07	1/179	45	Inclination between drilling and reference side P03 = 0: Inclination between drilling and reference side. P03 > 0: Inclination between drilling and front side.
P11	0/50000	HRS	Depth, orthogonal to reference side or front side.
P12	0/50000	20	Drill hole diameter

Tenon 1-050-X and 2-050-X

2-050-X

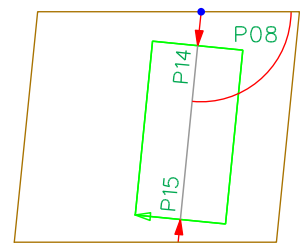
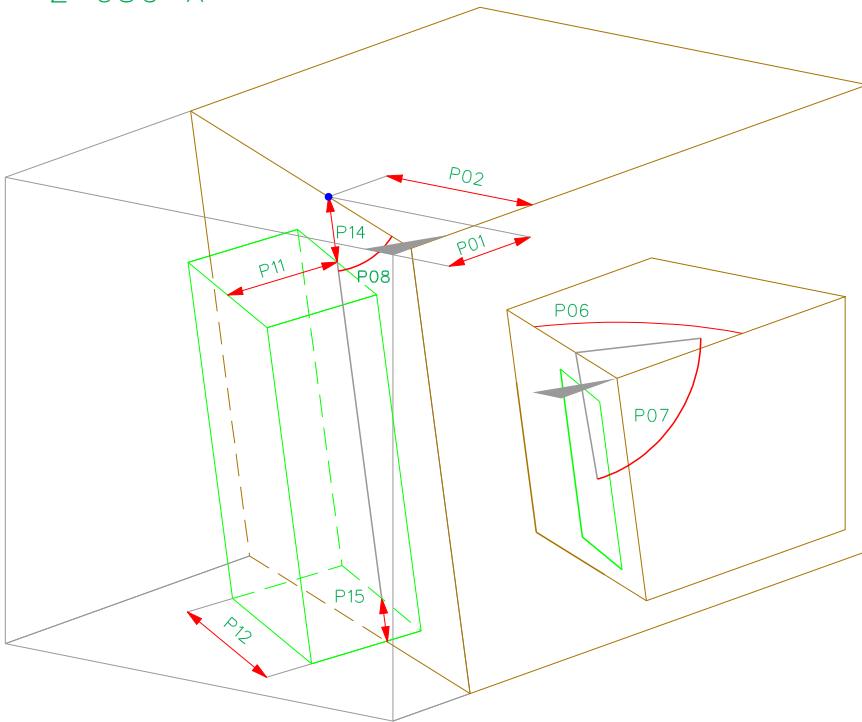

1-050-X

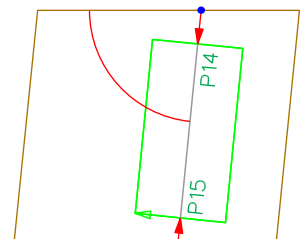
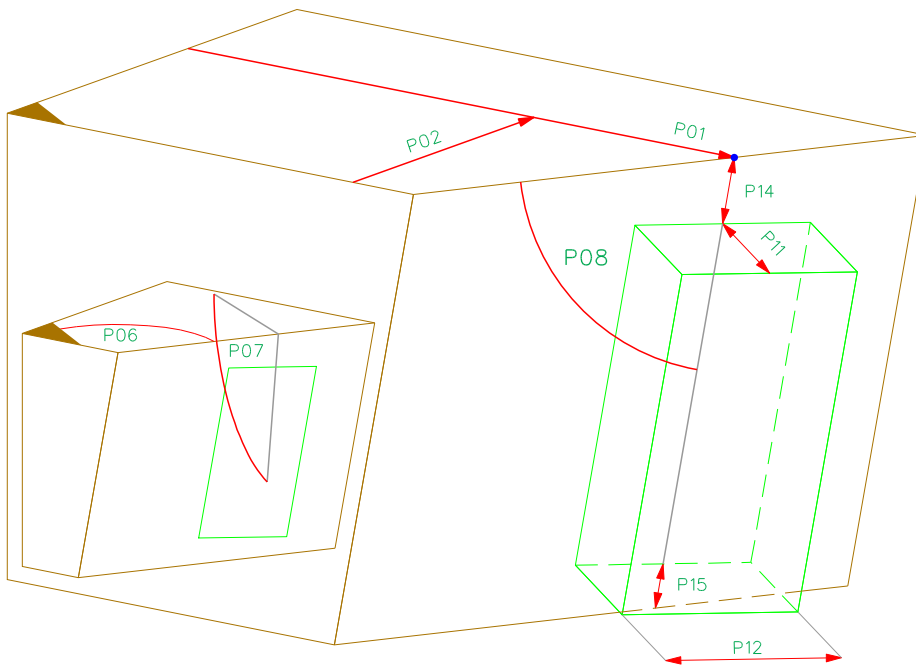

P05=0

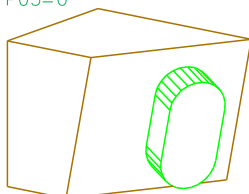

P05=1

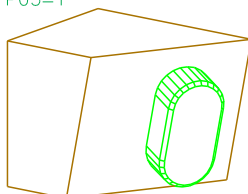

Parameters Tenon

1-050-X and 2-050-X

Parameter	Min/Max	Presetting	Description
P01	+/- 99999	0	Distance from beam start to the reference point
P02	+/- 50000	WRS/2	Distance from the reference edge to the reference point
P04	0/1/2/3/4	90	Rounding
P05	0/1	0	Chamfer
P06	1/179	90	Angle between cut edge and reference edge
P07	1/179	90	Inclination between face and reference side
P08	1/179	90	Angle between axis of the tenon and reference side
P10	0/500	0	Radius for P04=4
P11	1/1000	40	Tenon height
P12	1/1000	40	Tenon width
P14	+/- 50000	0	Margin on the reference side
P15	+/- 50000	0	Margin opposite the reference side

P04=0

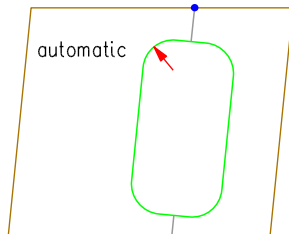

P04=1

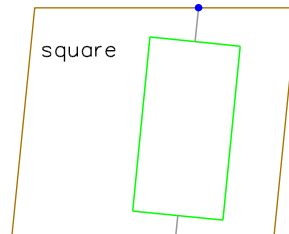

P04=2

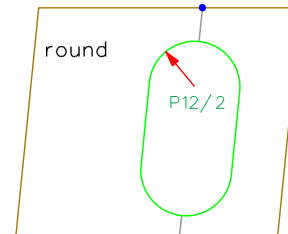

The tenon can be square, round or machine defined depending on the capabilities of the machine.

P04=3

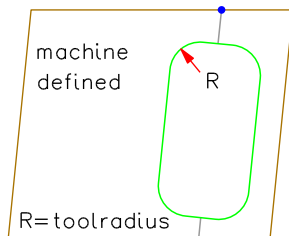

P04=4

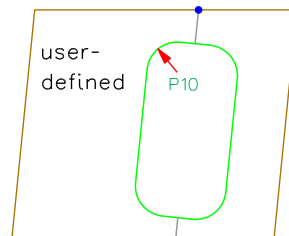

Mortise 3-050-X and 4-050-X

4-050-X

P08=90
P16=90

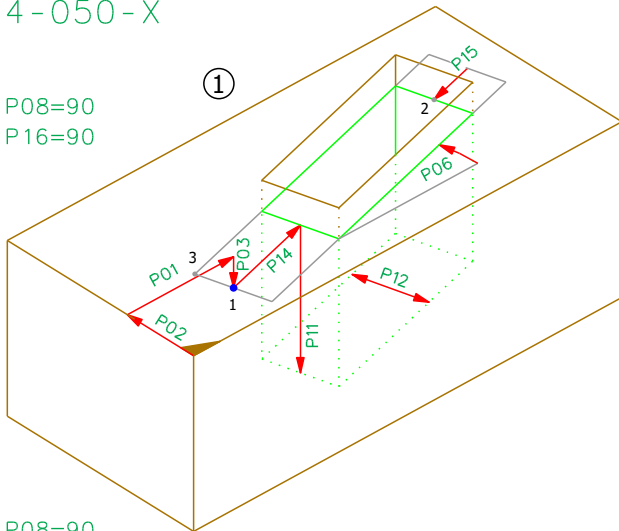

P08=90
P16=90-rotation_{1,3}

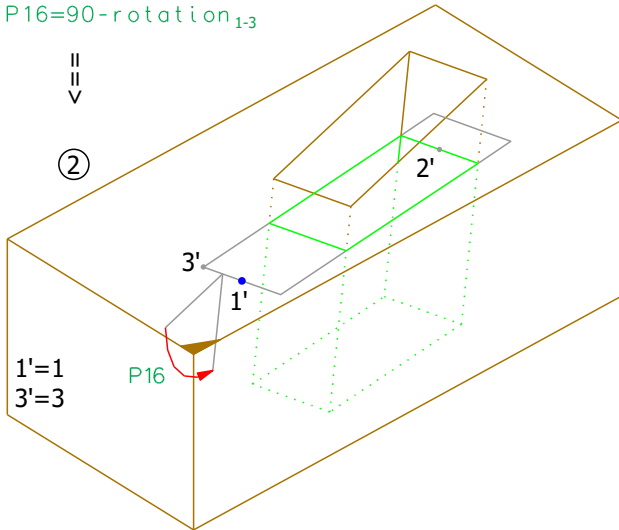

P08=90-rotation_{1',2'}

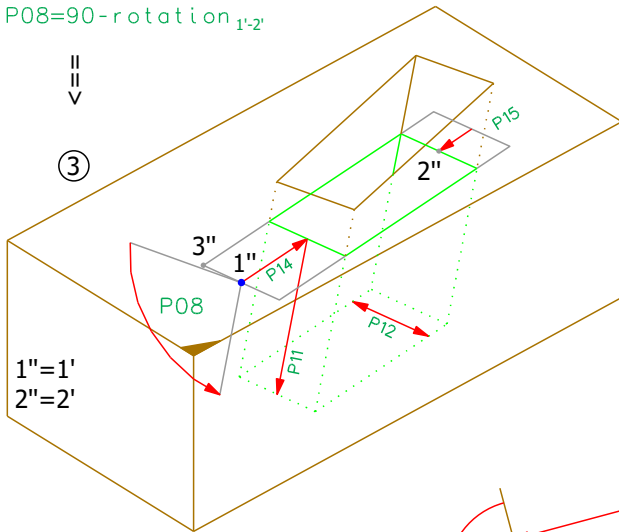

3-050-X

P08=90
P16=90

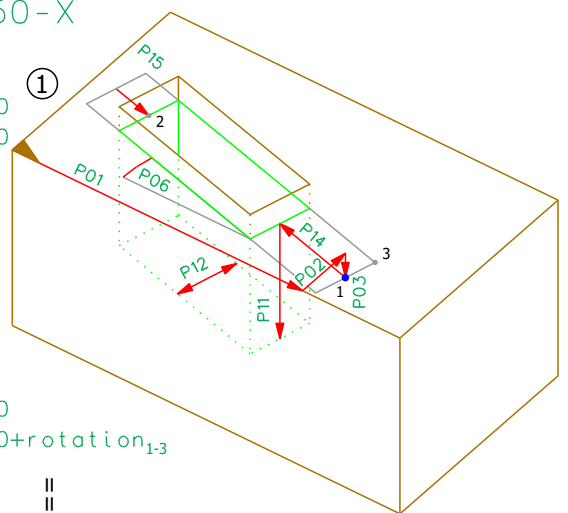

P08=90
P16=90+rotation_{1,3}

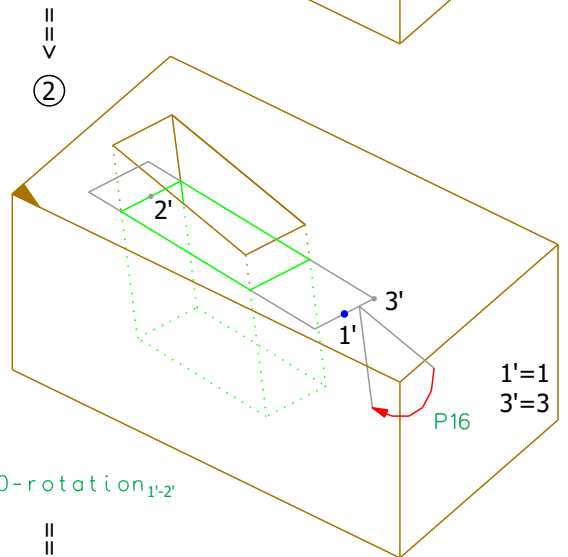

P08=90-rotation_{1',2'}

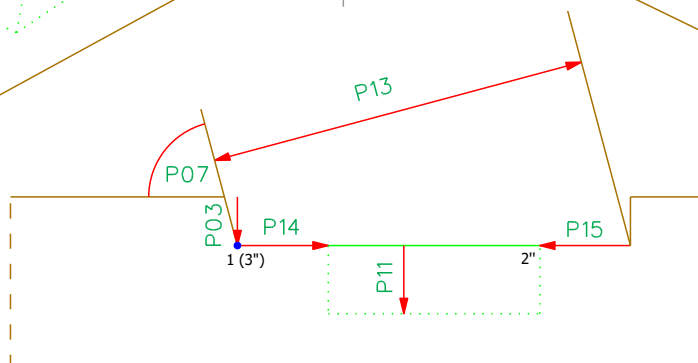
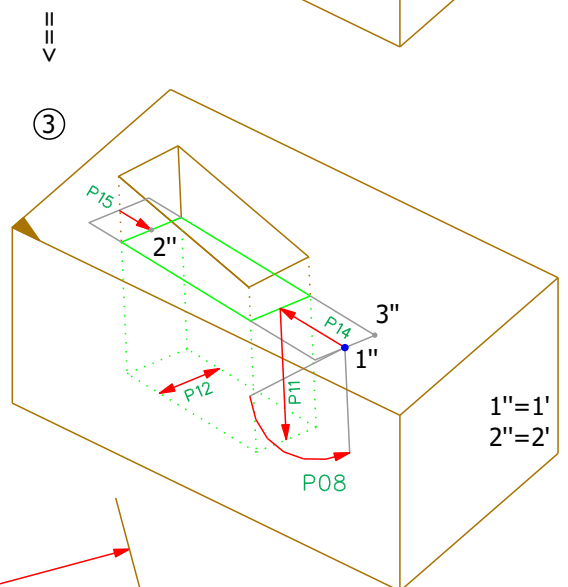

Parameters Mortise

3-050-X und 4-050-X

Parameter	Min/Max	Presetting	Description
P01	+/- 99999	0	Distance from beam start to the reference point
P02	+/- 50000	WRS/2	Distance from the reference edge to the reference point
P03	0/50000	0	Displacement to the reference side
P04	0/1/2/3/4	90	Rounding
P06	+/- 180	0	Angle between axis and reference edge
P07	1/179	90	Inclination between strut and reference side
P08	1/179	90	Inclination of hole side walls towards reference side
P10	0/500	0	Radius for P04=4
P11	0/1000	40	Mortise depth
P12	0/1000	40	Mortise width
P13	1/50000	200	Height of strut
P14	+/- 50000	0	Margin on the reference point
P15	+/- 50000	0	Margin opposite the reference point
P16	1/179	90	Inclination of hole front side towards reference side

P04=0

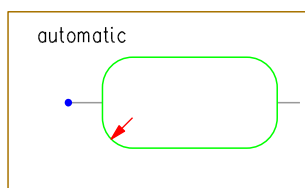

P04=1

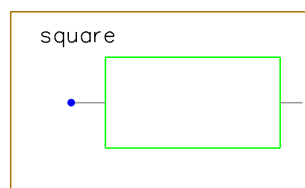

P04=2

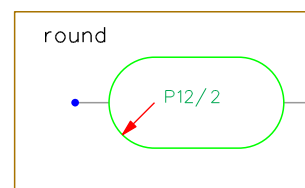

The mortise can be square, round or machine defined depending on the capabilities of the machine.

P04=3

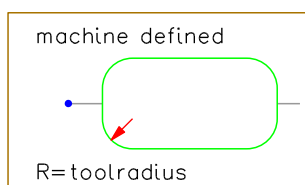

P04=4

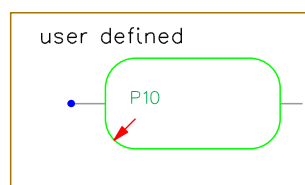

Mortise Front 3-051-X and 4-051-X

4-051-X

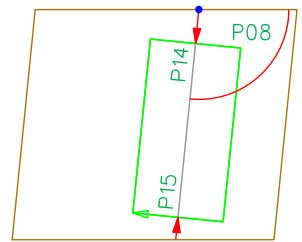
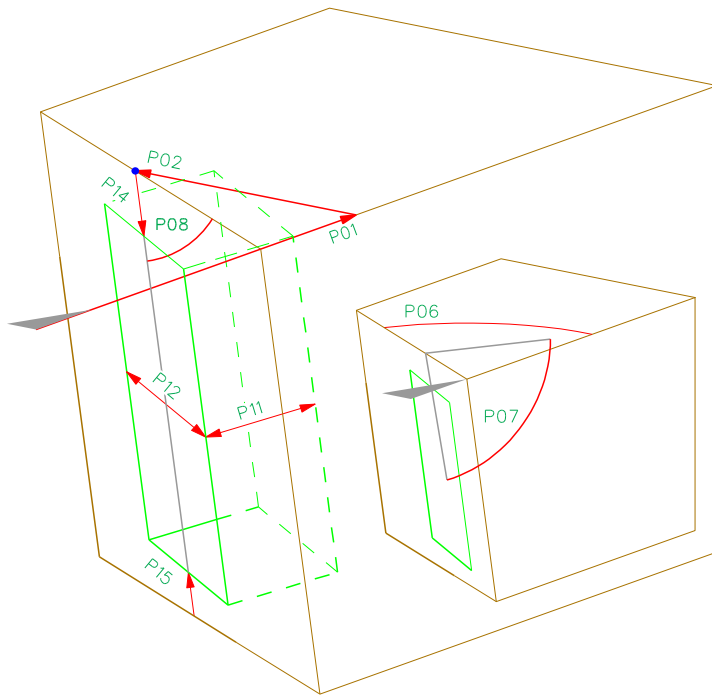

3-051-X

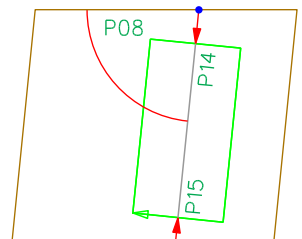
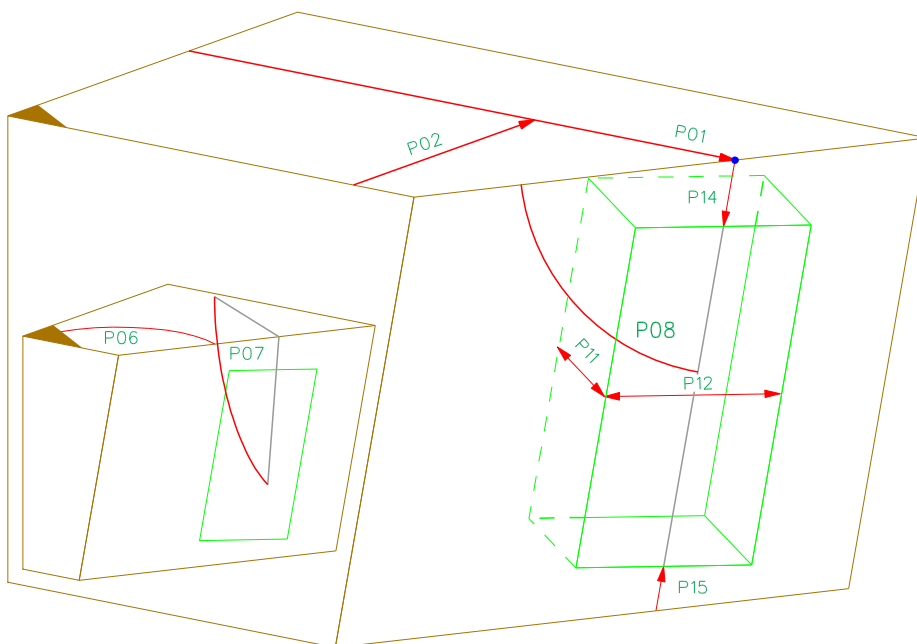

Parameters Mortise Front

3-051-X und 4-051-X

Parameter	Min/Max	Presetting	Description
P01	+/- 99999	0	Distance from beam start to the reference point
P02	+/- 50000	WRS/2	Distance from the reference edge to the reference point
P04	0/1/2/3/4	90	Rounding
P06	1/179	90	Angle between cut edge and reference edge
P07	1/179	90	Inclination between face and reference side
P08	1/179	90	Angle between axis of the tenon and reference side
P10	0/500	0	Radius for P04=4
P11	1/1000	40	Mortise depth
P12	1/1000	40	Mortise width
P14	+/- 50000	0	Margin on the reference side
P15	+/- 50000	0	Margin opposite the reference side

P04=0

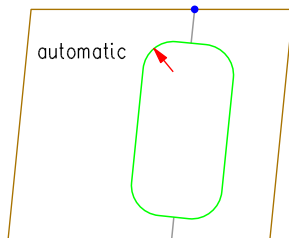

P04=1

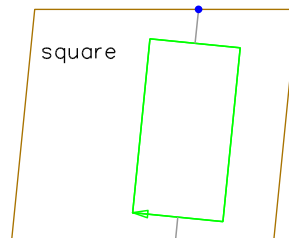

P04=2

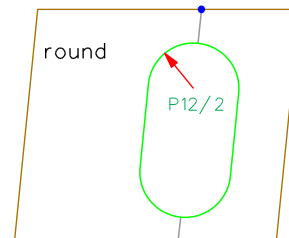

The mortise can be square, round or machine defined depending on the capabilities of the machine.

P04=3

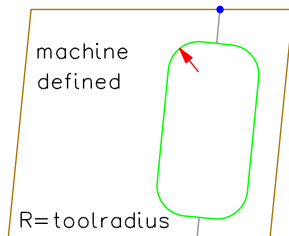

P04=4

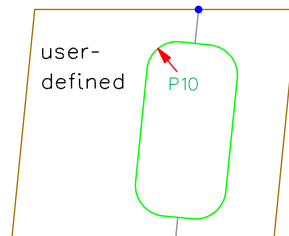

House 3-052-X and 4-052-X

tenon or dovetail tenon

house

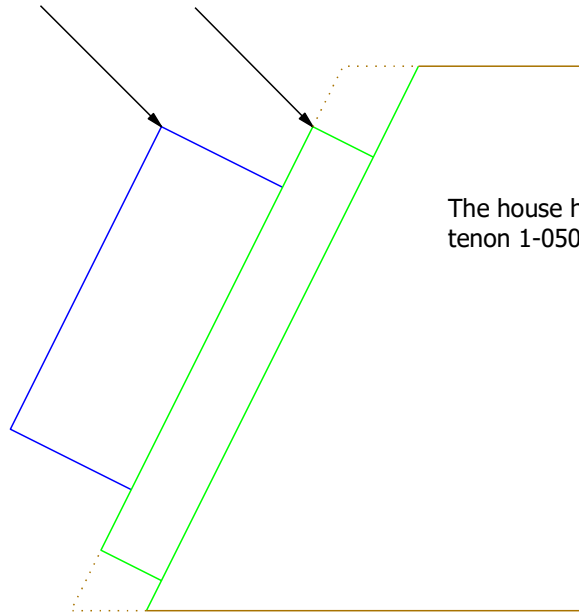

The house has the same description as the tenon 1-050-X and 2-050-X.

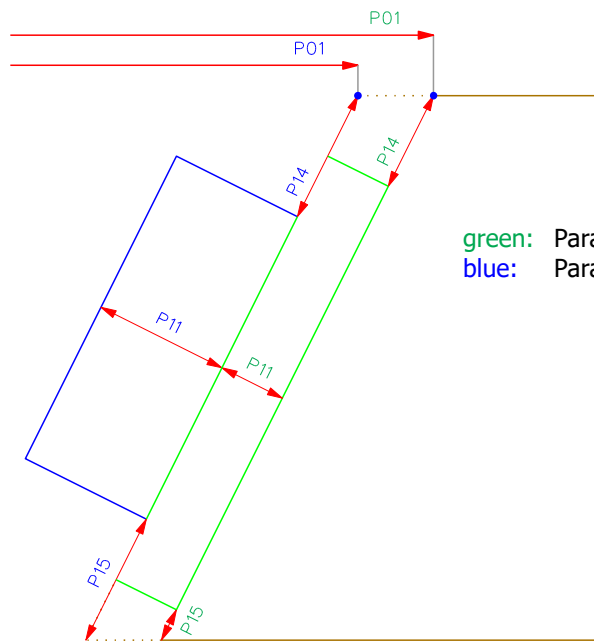

green: Parameters for house.

blue: Parameters for tenon or dovetail tenon

Parameters House

3-052-X and 4-052-X

The house has same parameters as 1-050-X and 2-050-X, except P09 and P05.

Parameter	Min/Max	Presetting	Description
P05	-	-	Not defined
P09	0/99999	0	Processident of the associated tenon or dovetail tenon

House Mortise 3-053-X and 4-053-X

The house mortise has the same description as the mortise 3-050-X and 4-050-X.

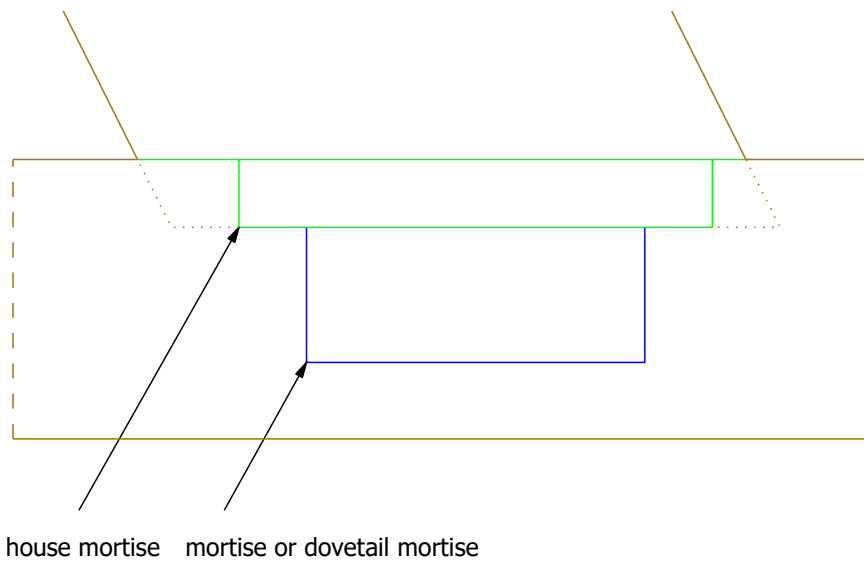

Parameters House Mortise

3-053-X and 4-053-X

The house mortise has same parameters as 3-050-X and 4-050-X, except P09.

Parameter	Min/Max	Presetting	Description
P09	0/99999	0	Processident of the associated mortise or dovetail mortise

Dovetail Tenon 1-055-X and 2-055-X

2-055-X

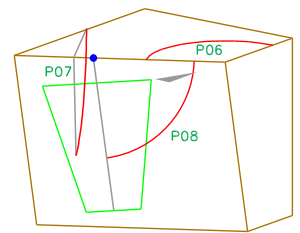
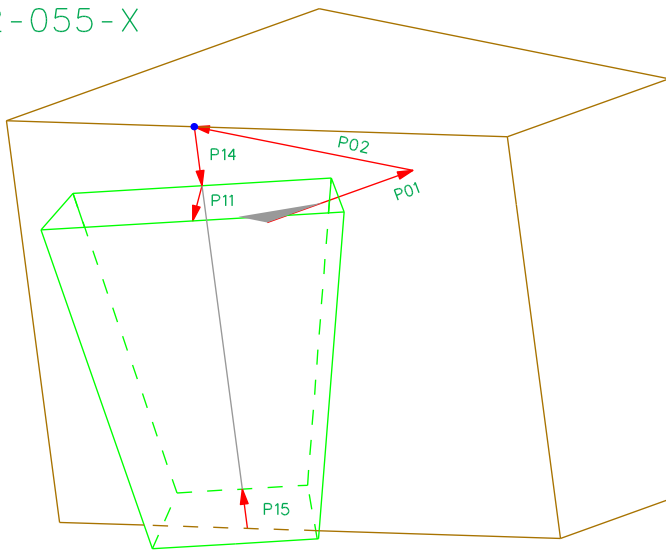

1-055-X

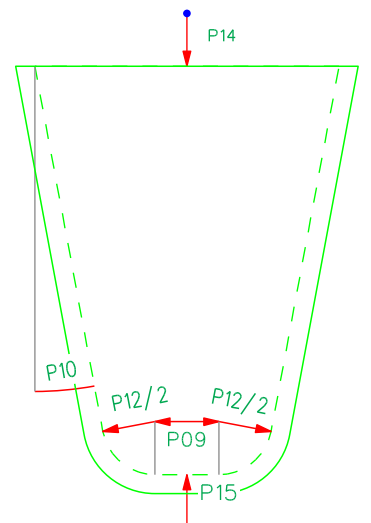
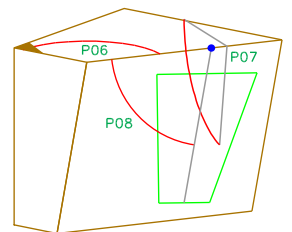
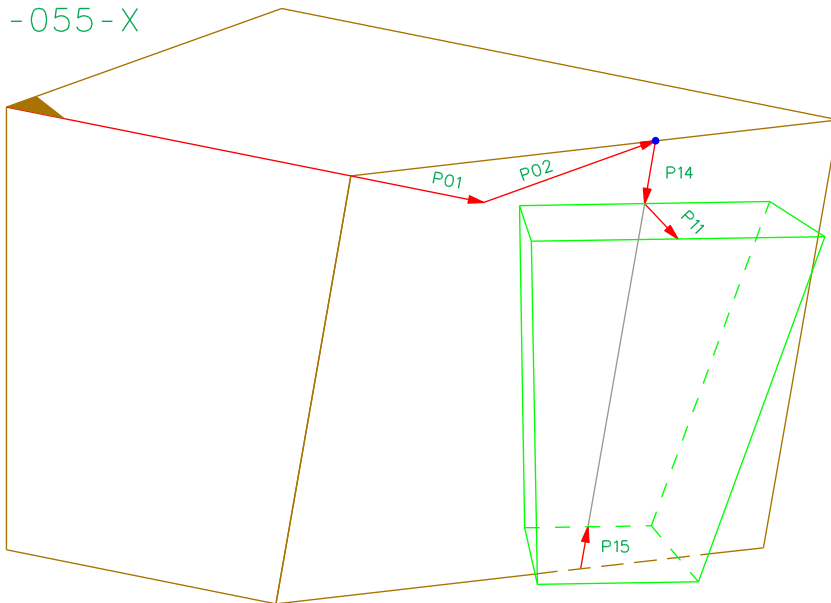

Parameters Dovetail Tenon

1-055-X and 2-055-X

Parameter	Min/Max	Presetting	Description
P01	+/- 99999	0	Distance from beam start to the reference point
P02	+/- 50000	WRS/2	Distance from the reference edge to the reference point
P04	0/1	0	0=with rounding at the bottom; 1=without rounding, unbounded
P06	1/179	90	Angle between edge and reference edge
P07	1/179	90	Inclination between face and reference side
P08	1/179	90	Angle between axis of the tenon and reference side
P09	0/1000	0	Middle flattening
P10	0/30	0	Angle of cone
P11	1/1000	28	Tenon height
P12	+/- 1000	45	Diameter of the curve If P12 < 0, then the radius must be defined on the machineside.
P14	+/- 50000	0	Margin on the reference side
P15	+/- 50000	0	Margin opposite the reference side

P04=0

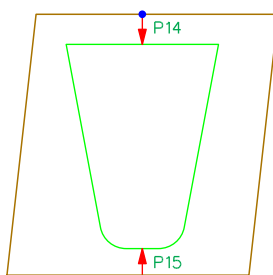

P04=1

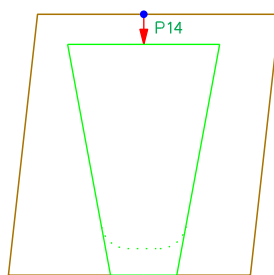

Dovetail Mortise 3-055-X and 4-055-X

4-055-X

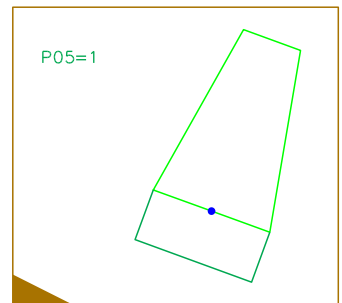
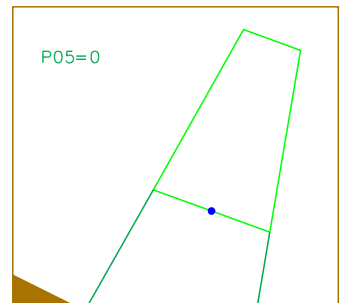
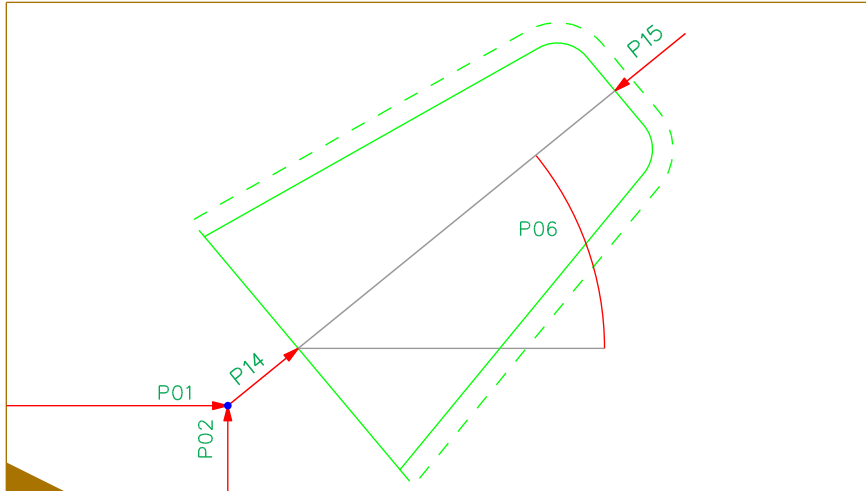

3-055-X

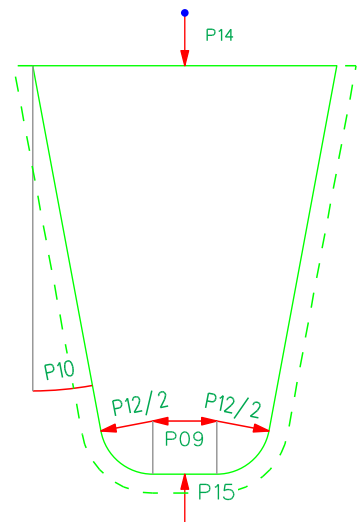
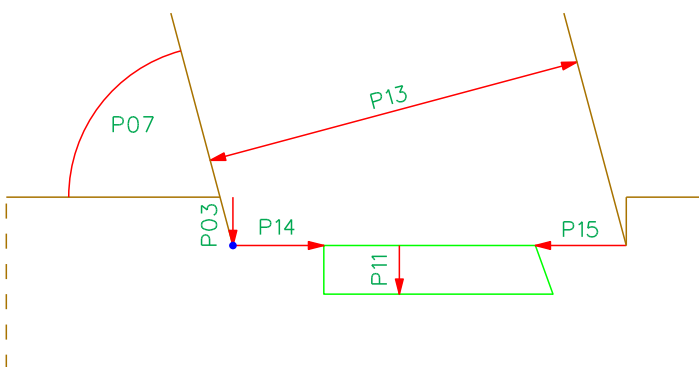
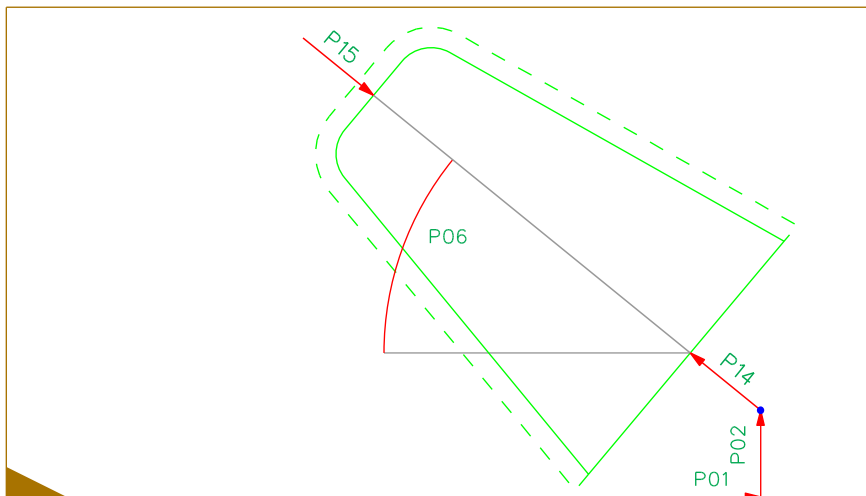

Parameters Dovetail Mortise

3-055-X und 4-055-X

Parameter	Min/Max	Presetting	Description
P01	+/- 99999	0	Distance from beam start to the reference point
P02	+/- 50000	WRS/2	Distance from the reference edge to the reference point
P03	0/50000	0	Displacement to the reference side
P04	0/1	0	0=with rounding at the bottom; 1=without rounding, unbounded
P05	0/1	0	0=with elongation; 1=with pocket
P06	+/- 180	0	Angle between axis and reference edge
P07	1/179	90	Inclination between strut and reference side
P09	0/1000	0	Middle flattening
P10	0/30	0	Angle of cone
P11	1/1000	28	Mortise depth
P12	+/- 1000	45	Diameter of the curve If P12 < 0, then the radius must be defined on the machineside.
P13	1/50000	200	Height of strut
P14	+/- 50000	0	Margin on the reference point
P15	+/- 50000	0	Margin opposite the reference point

P04=0

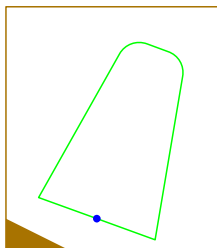

P04=1

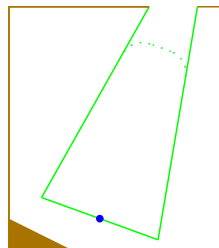

Dovetail Mortise Front 3-056-X and 4-056-X

4-056-X

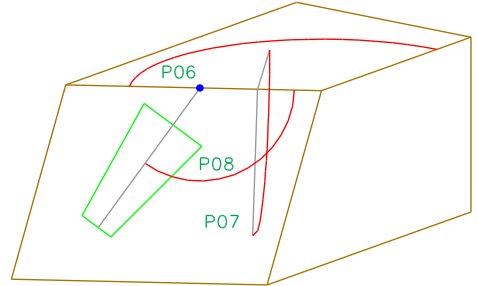
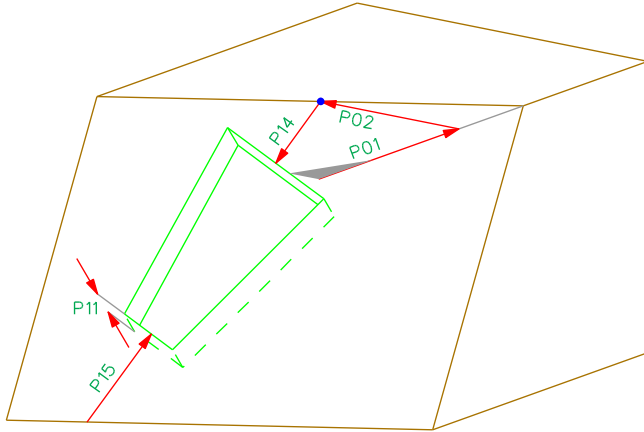

3-056-X

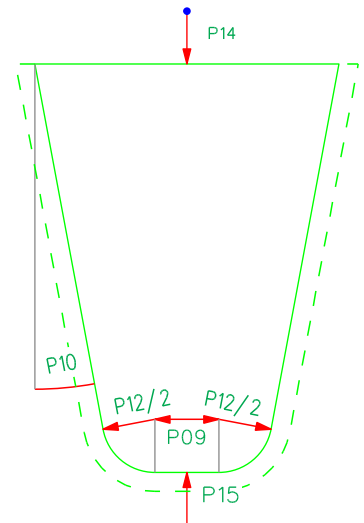
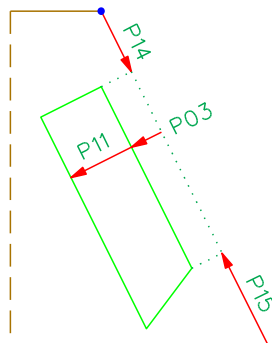
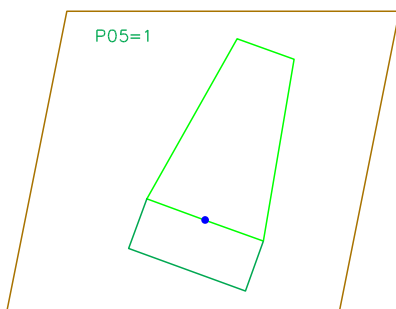
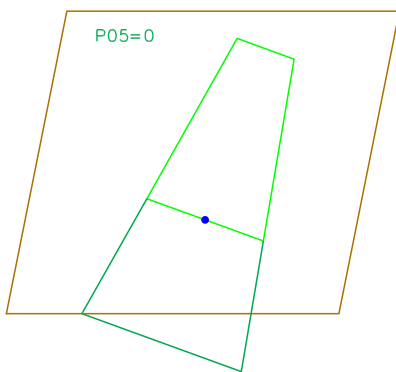
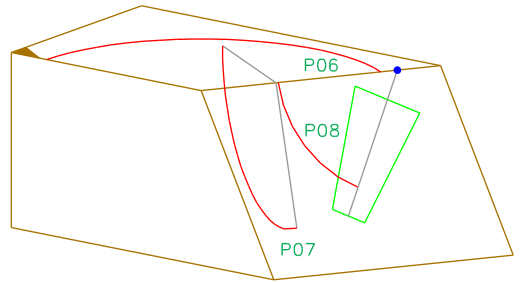
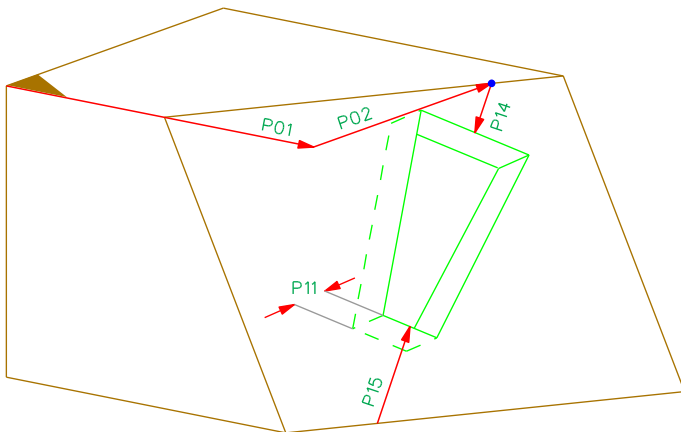

Parameters Dovetail Mortise Front

3-056-X und 4-056-X

Parameter	Min/Max	Presetting	Description
P01	+/- 99999	0	Distance from beam start to the reference point
P02	+/- 50000	WRS/2	Distance from the reference edge to the reference point
P03	0/50000	0	Displacement to the front side
P04	0/1	0	0=with rounding at the bottom; 1=without rounding, unbounded
P05	0/1	0	0=with elongation; 1=with pocket
P06	1/179	90	Angle between cut edge and reference edge
P07	1/179	90	Inclination between face and reference side
P08	1/179	90	Angle between axis of the tenon and reference side
P09	0/1000	0	Middle flattening
P10	0/30	0	Angle of cone
P11	1/1000	28	Mortise depth
P12	0/1000	45	Diameter of the curve If P12 < 0, then the radius must be defined on the machineside.
P14	+/- 50000	0	Margin on the reference side
P15	+/- 50000	0	Margin opposite the reference side

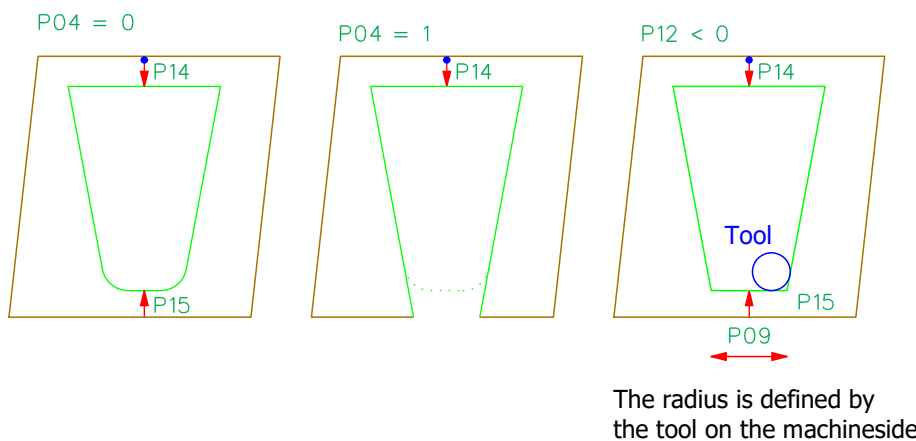

Marking / Labeling 3-060-X and 4-060-X



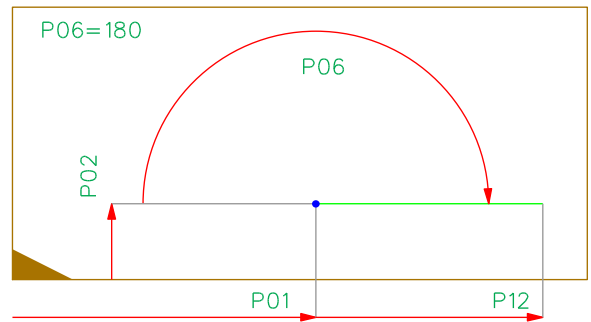
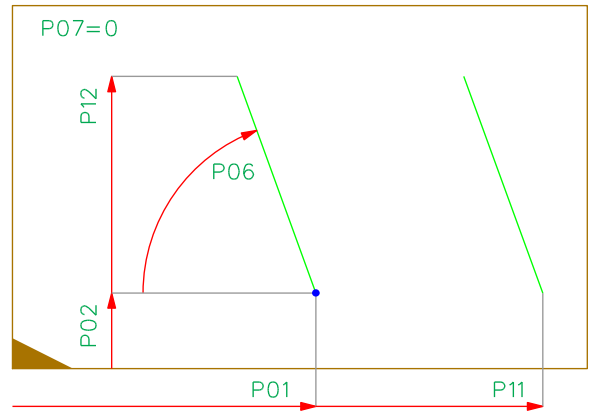
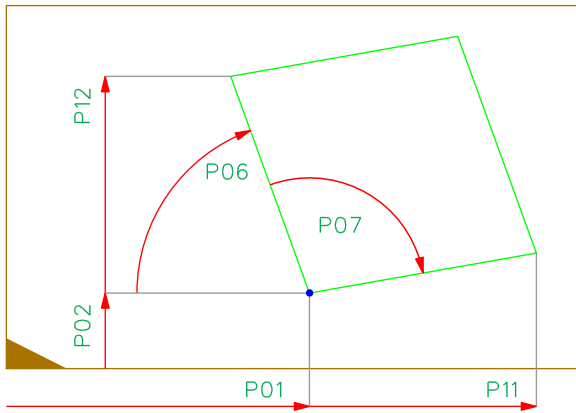

4-060-X

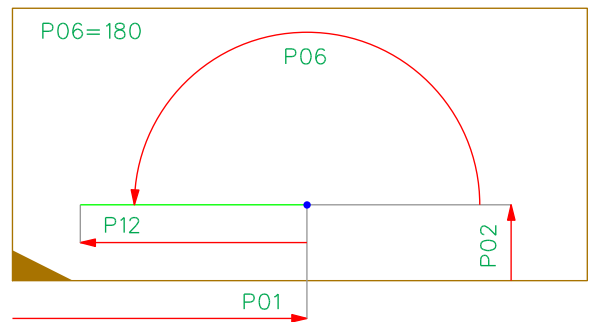
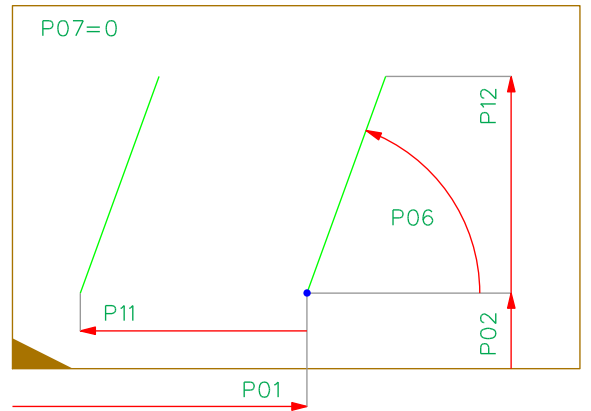
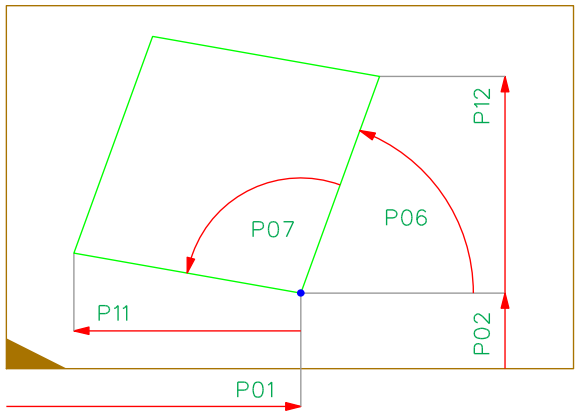

3-060-X

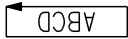

P04:

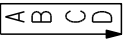
Bit	0	1
0	Marking	No marking
1		Text at reference edge
2		Text in the middle
3		Text opposite to reference edge
4		Text on the left side of marking
5		Text between marking
6		Text on the right side of marking
7		standard 
8		turned to right 
9		upside down 
10		turned to left 
11	Letters standard 	Letters vertically placed 
12		Text below the reference point
13		Text at the reference point
14		Text above the reference point

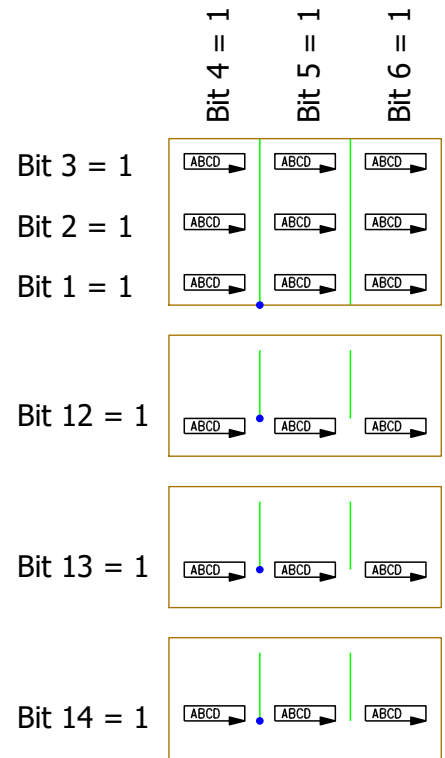

ABCD 

The text is not aligned to the edges defined by P06 / P07.
It is aligned to these edges:

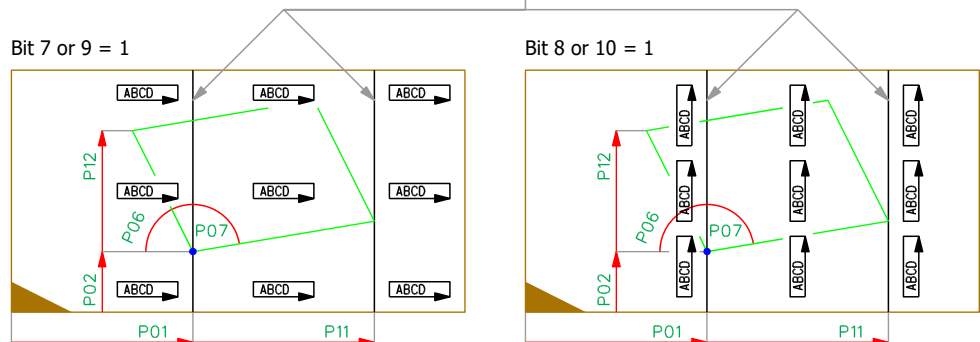

Parameters Marking / Labeling

3-060-X und 4-060-X

Parameter	Min/Max	Presetting	Description
P01	+/- 99999	0	Distance from beam start to the reference point
P02	+/- 50000	0	Distance from the reference edge to the reference point
P04	0/19521 Only sensible combinations	0 (no text) 146 (with text)	Position and alignment of the text. P04 = 0 if there is no text.
P06	1/180	90	Angle between axis and reference edge If P06 equals 180°, then a horizontal line is defined, P12 defines the length of the line.
P07	0/179	90	Interior angle If P07 equals zero, 2 single markings have to be produced
P11	0/50000	100	Width of quadrangle If P11 equals zero, there is only a single marking
P12	0/50000	0	Height of quadrangle If P12 equals zero, marking is limited by the edge opposite to the reference edge
P13	0/50000	200	Height of text If P13 equals zero, the machine determines the text height.
P15		""	Text (String max. 256 characters) Example: P15:"Rafter left"

Text 4-061-X

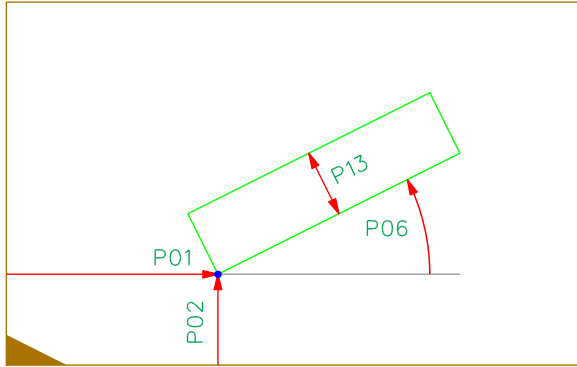

P09 = 0 P10 = 0

ABCD

P09 = 0 P10 = 1

ABCD

P09 = 0 P10 = 2

ABCD

P13

P15: "ABCD"

P09 = 1 P10 = 0

ABCD

P09 = 1 P10 = 1

ABCD

P09 = 1 P10 = 2

ABCD

P09 = 2 P10 = 0

ABCD

P09 = 2 P10 = 1

ABCD

P09 = 2 P10 = 2

ABCD

P11 = 0

ABCD
EF
GHI

P11 = 1

ABCD
EF
GHI

P11 = 2

ABCD
EF
GHI

P13

P15: "ABCD\nEF\nGHI"

P12 = 0

ABCD

P12 = 1

◀mU□

Parameters Text

4-061-X

Parameter	Min/Max	Presetting	Description
P01	+/- 99999	0	Distance from beam start to the reference point
P02	+/- 50000	0	Distance from the reference edge to the reference point
P06	-180/+180	0	Angle between axis and reference edge
P09	0/2	0	Alignment vertical 0 = bottom, 1=middle, 2=top
P10	0/2	0	Alignment horizontal 0 = left, 1=middle, 2=right
P11	0/2	0	Alignment in case of a multiline text 0 = left-aligned, 1=centered, 2=right-aligned A new line must be defined with this 2 letters: \n
P12	0/1	0	Letters standard or horizontal placed 0 = standard, 1=letters horizontal placed
P13	0/50000	200	Height of text If P13 equals zero, the machine determines the text height.
P15		""	Text (String max. 256 characters) Example: P15:"Rafter left"

Simple Scarf 1-070-X and 2-070-X

2-070-X

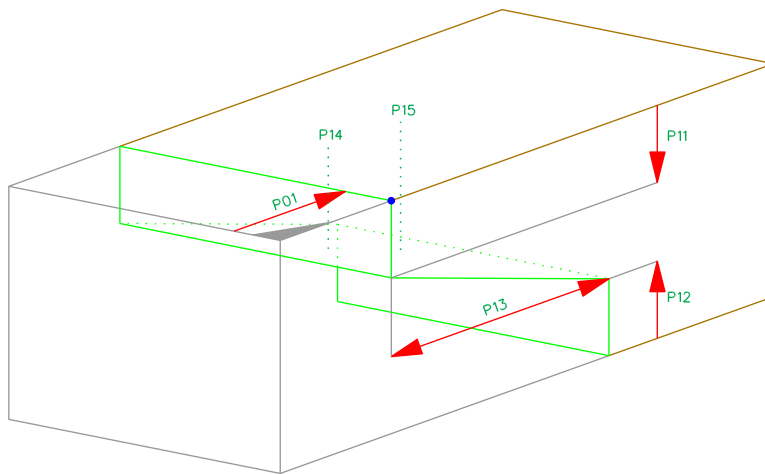

1-070-X

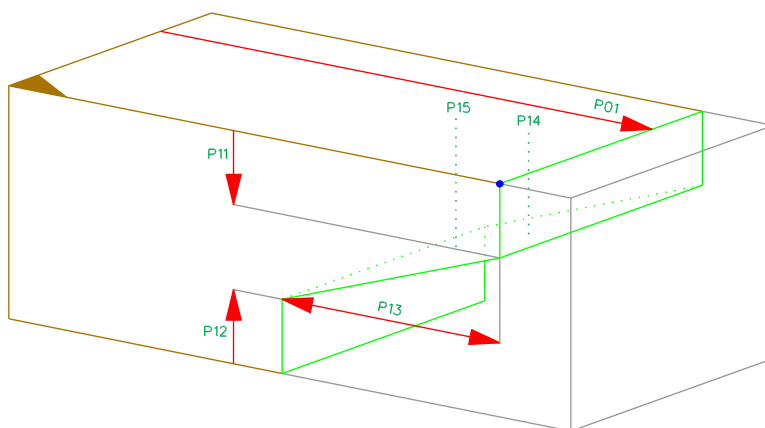

Parameters Simple Scarf

1-070-X and 2-070-X

Parameter	Min/Max	Presetting	Description
P01	+/- 50000	0	Distance from beam start to the reference point
P11	0/50000	20	Depth at the reference side
P12	0/50000	20	Depth at the opposite of reference side
P13	1/50000	200	Length of the overlap
P14	0/1000	0	Drilling 1 diameter P15=0: This drilling is placed at 1/2 P13 P15>0: This drilling is placed at 1/3 P13
P15	0/1000	0	Drilling 2 diameter Placed at 2/3 P13

Scarf Joint 1-071-X and 2-071-X

2-071-X

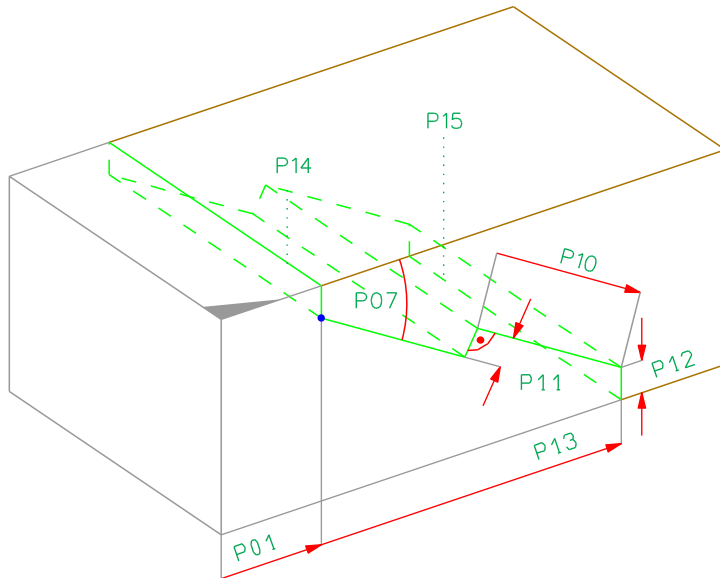

P09 = 0

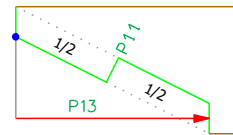

P09 = 1

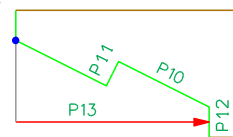

P09 = -1

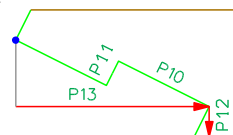

1-071-X

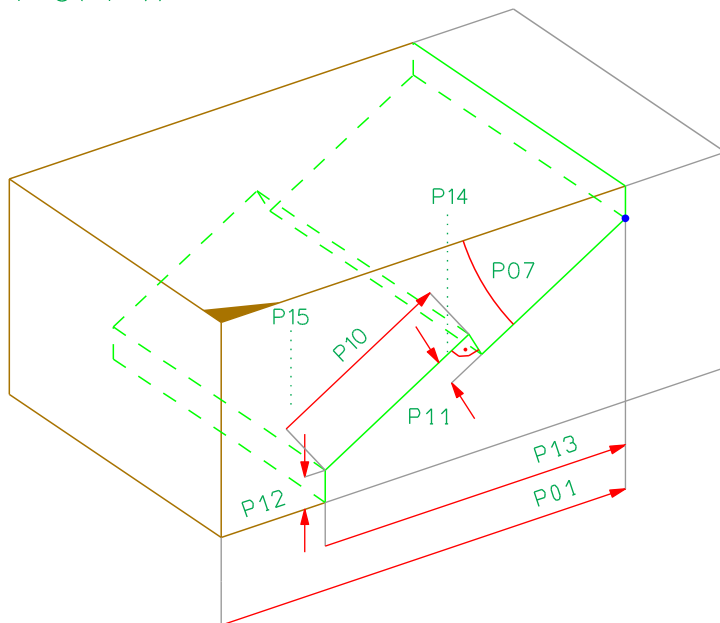

P09 = 0

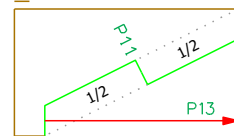

P09 = 1

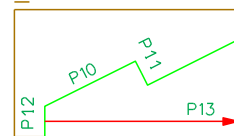

P09 = -1

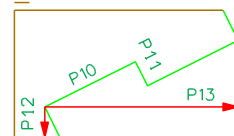

Parameters Scarf Joint

1-071-X and 2-071-X

Parameter	Min/Max	Presetting	Description
P01	+/- 99999	0	Distance from beam start to the reference point
P07	0/90	0	Angle of inclination of the lapped scarf base
P09	-1/1	1	Shape of the lapped scarf or classic data identification: 1: when cutting orthogonal to reference side -1: when cutting orthogonal to base side 0: classic definition, P10 and P12 are not used
P10	0/50000	0	Length of the lapped scarf base
P11	1/50000	20	Depth of the lapped scarf base
P12	0/50000	0	Depth of the lapped scarf base orthogonal to reference side
P13	1/50000	200	Length
P14	0/1000	0	Drilling 1 diameter P15=0: This drilling is placed at 1/2 P13 P15>0: This drilling is placed at 1/3 P13
P15	0/1000	0	Drilling 2 diameter Placed at 2/3 P13

Step Joint 1-080-X and 2-080-X

2-080-X

1-080-X

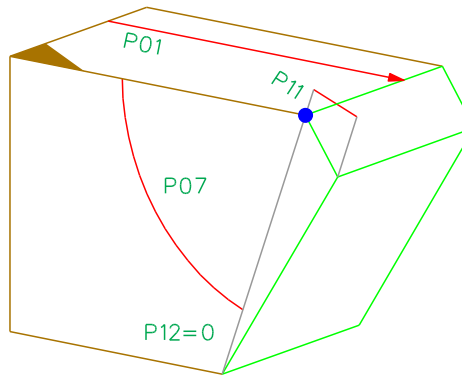
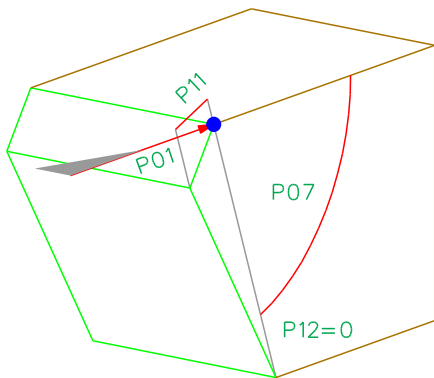
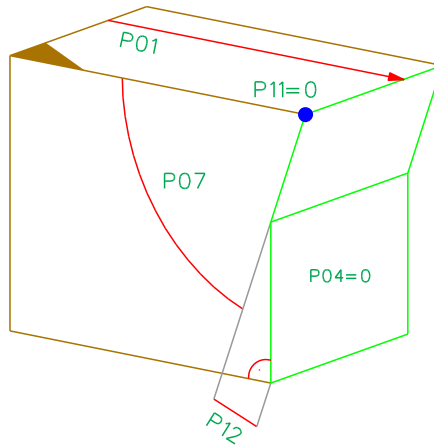
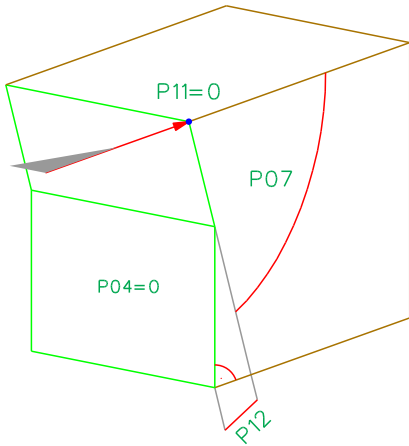
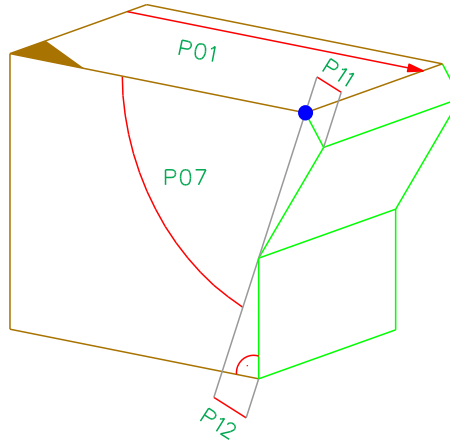
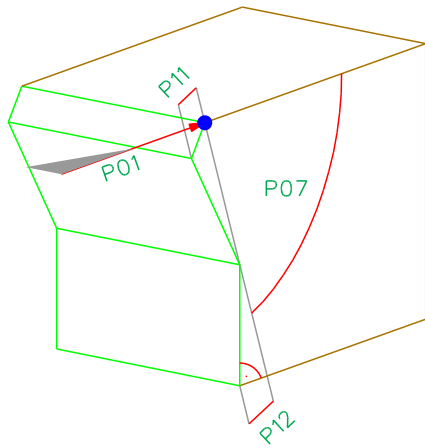

Sideviews 2-080-X

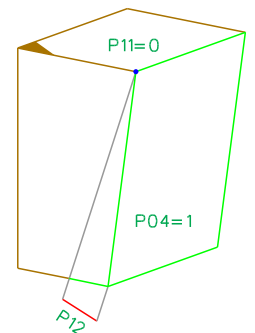
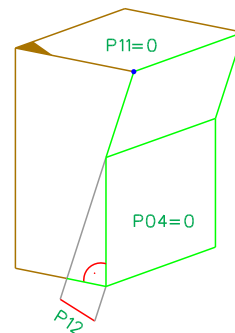
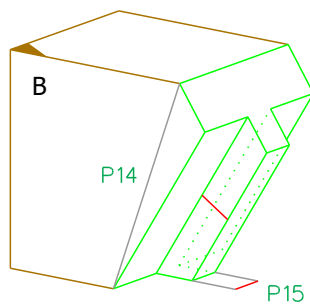
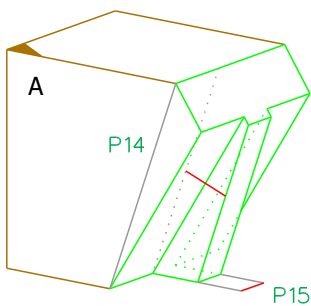
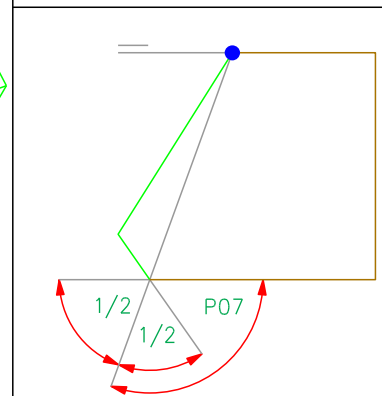
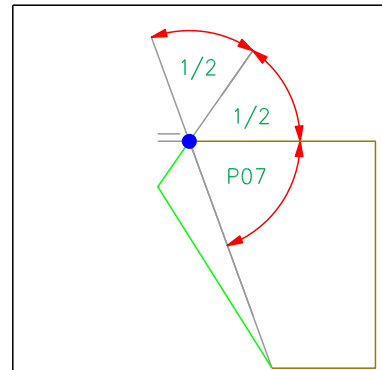

Parameters Step Joint

1-080-X and 2-080-X

Parameter	Min/Max	Presetting	Description
P01	+/- 99999	0	Distance from beam start to the reference point
P04	0/1	0	Type of heel notch: 0=normal; 1=tapered
P07	1/179	45	Inclination strut
P11	0/1000	20	Depth step joint
P12	0/1000	20	Depth heel notch
P14	0/1000	0	Height tenon Which implementation (A or B) is used depends on the machine
P15	0/1000	0	Width tenon

Step Joint Notch 3-080-X and 4-080-X

4-080-X

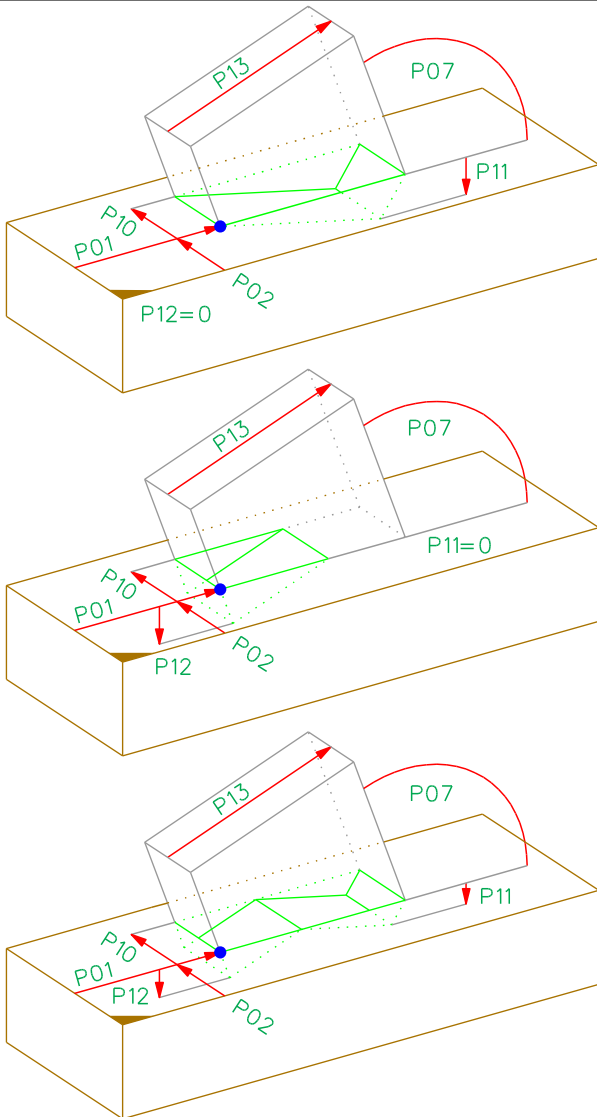

3-080-X

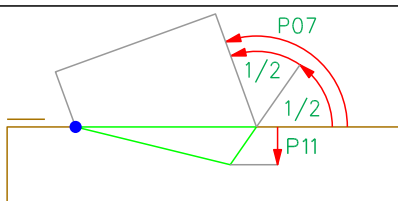
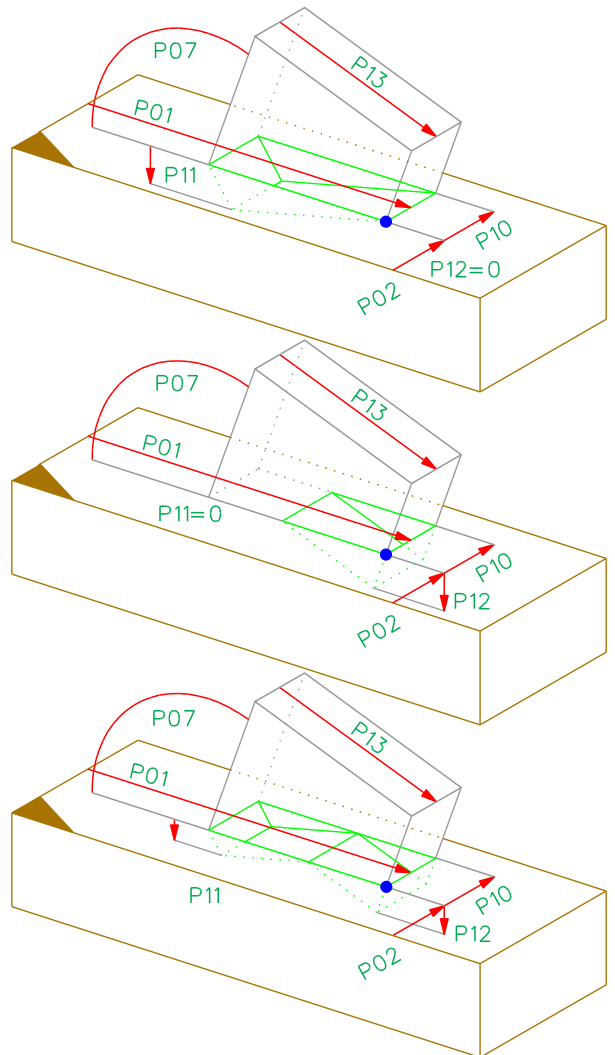

$P07 > 90^\circ$
 $P11 > 0$
 $P12 = 0$

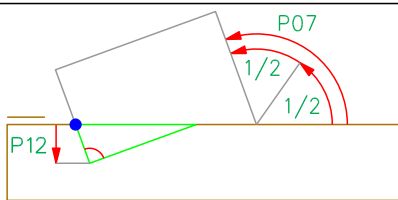
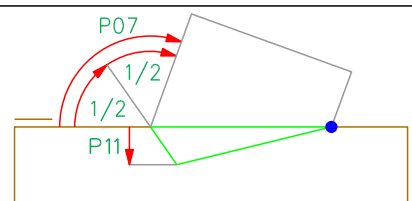

$P07 > 90^\circ$
 $P11 = 0$
 $P12 > 0$
 $P04 = 0$

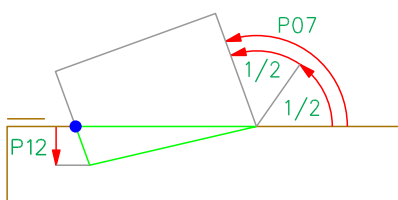
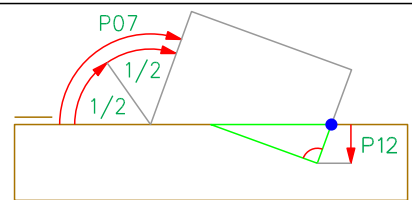

$P07 > 90^\circ$
 $P11 = 0$
 $P12 > 0$
 $P04 = 1$

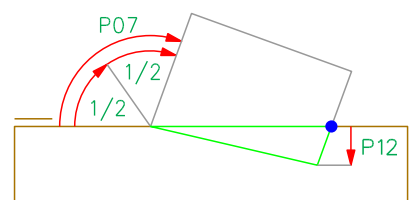

4-080-X		3-080-X
	$P07 < 90^\circ$ $P11 > 0$ $P12 = 0$	
	$P07 < 90^\circ$ $P11 = 0$ $P12 > 0$ $P04 = 0$	
	$P07 < 90^\circ$ $P11 = 0$ $P12 > 0$ $P04 = 1$	

Parameters Step Joint Notch

3-080-X and 4-080-X

Parameter	Min/Max	Presetting	Description
P01	+/- 99999	0	Distance from beam start to the reference point
P02	+/- 50000	0	Distance from the reference edge to the reference point
P04	0/1	0	Type of heel notch: 0=normal; 1=tapered
P07	1/179	45	Inclination between strut and reference side
P10	0/50000	WRS	Width of the notch
P11	0/1000	20	Depth step joint
P12	0/1000	20	Depth heel notch
P13	1/50000	200	Height of strut
P14	0/1000	0	Depth of mortise Which implementation (A or B) is used depends on the machine
P15	0/1000	0	Width of mortise

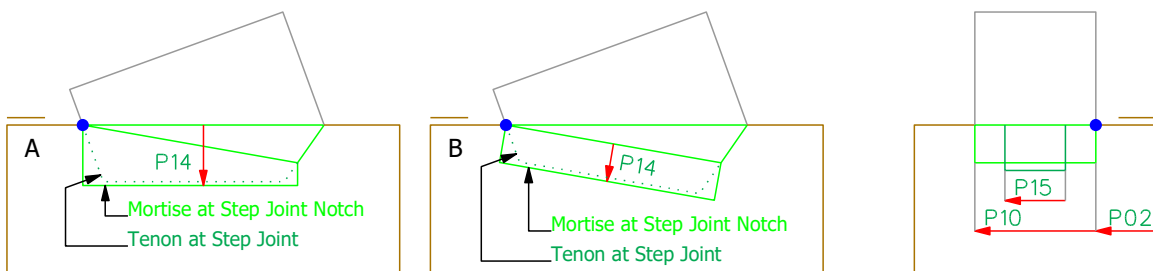

Planing 3-090-X and 4-090-X

4-090-X

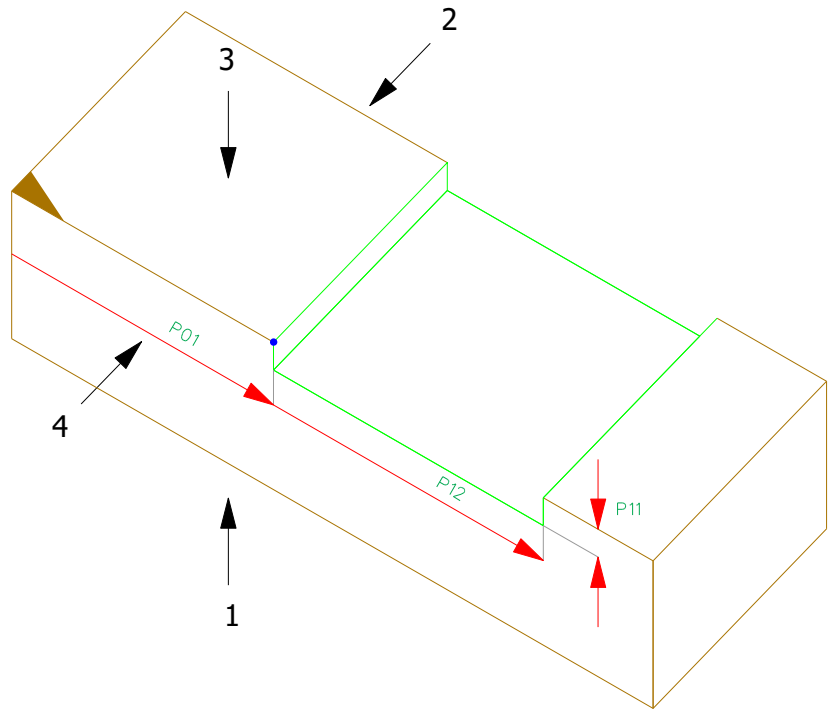

P04 = binary code

	2^0	2^1	2^2	2^3
Binary	1	2	4	8
Reference side	1	2	3	4

Examples

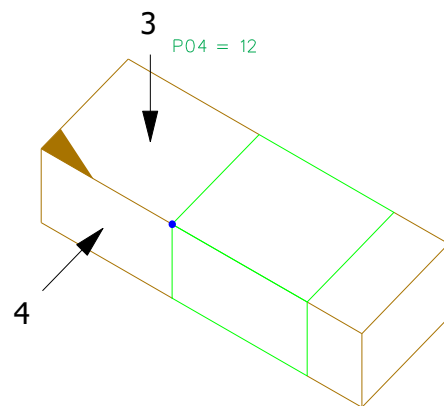
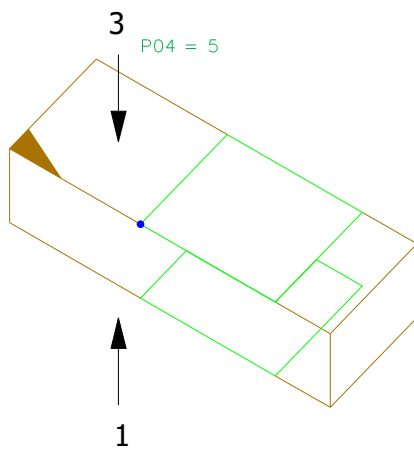

Parameters Planing

3-090-X and 4-090-X

Parameter	Min/Max	Presetting	Description
P01	+/- 99999	0	Distance from beam start to the reference point
P04	1/15	15	Specification of side(s) to be planed; binary coded
P11	0/50	1	Planing depth
P12	+/- 99999	LRS	Length of the area to be planed

Profile Front 3-100-X and 4-100-X

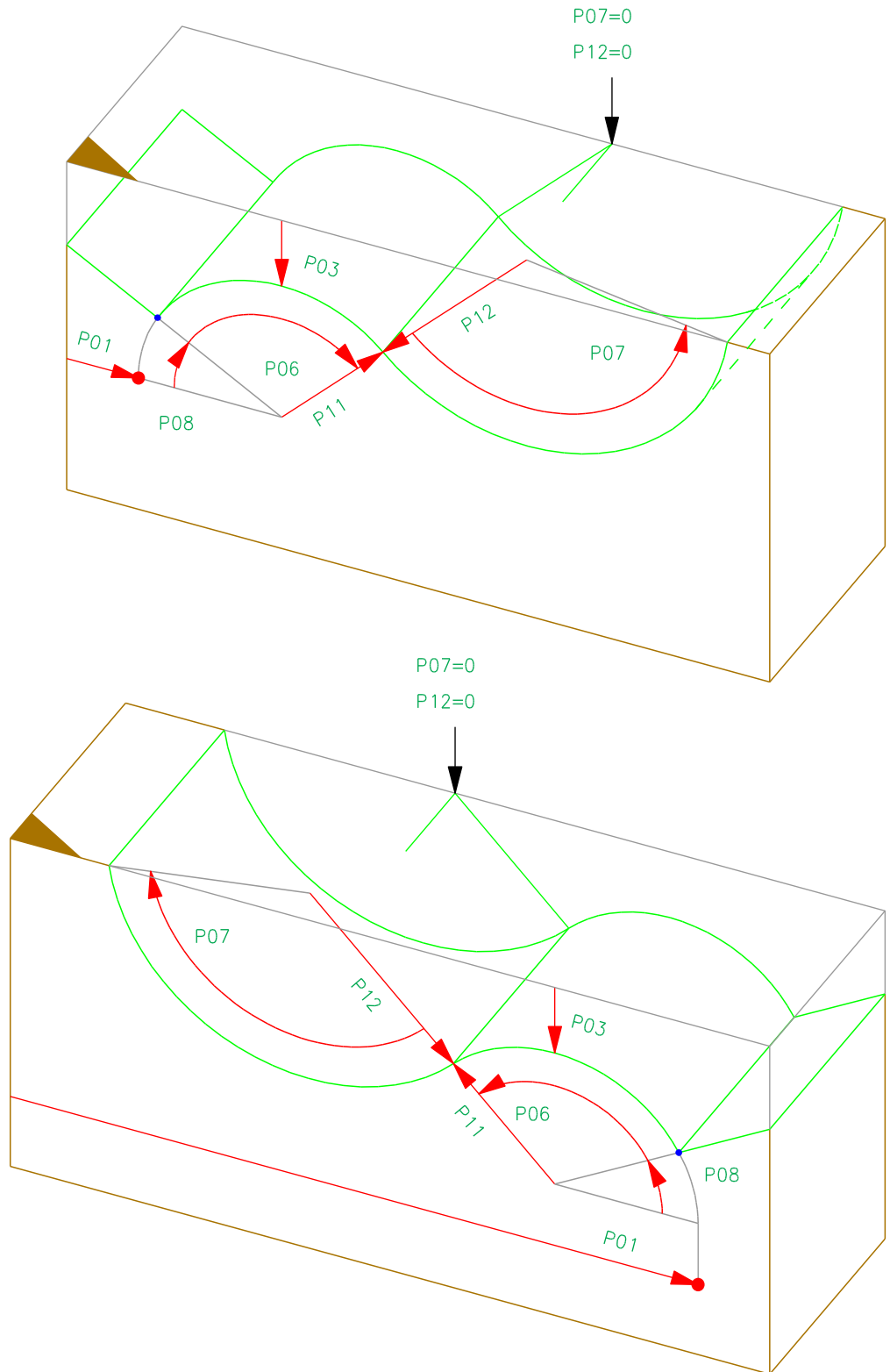

Parameters Profile Front

3-100-X and 4-100-X

Parameter	Min/Max	Presetting	Description
P01	+/- 99999	0	Distance from beam start to the reference point
P03	+/- 1000	0	Distance from the reference edge to the reference point
P06	0/180	90	Rotation angle of the first curve of the profile
P07	0/180	90	Rotation angle of the profile towards the reference edge
P08	+/- 180	0	Offset angle
P11	+/- 1000	250	Radius of the first curve
P12	+/- 1000	250	Radius of the second curve

Profile Head concave 3-101-X and 4-101-X

4-101-X

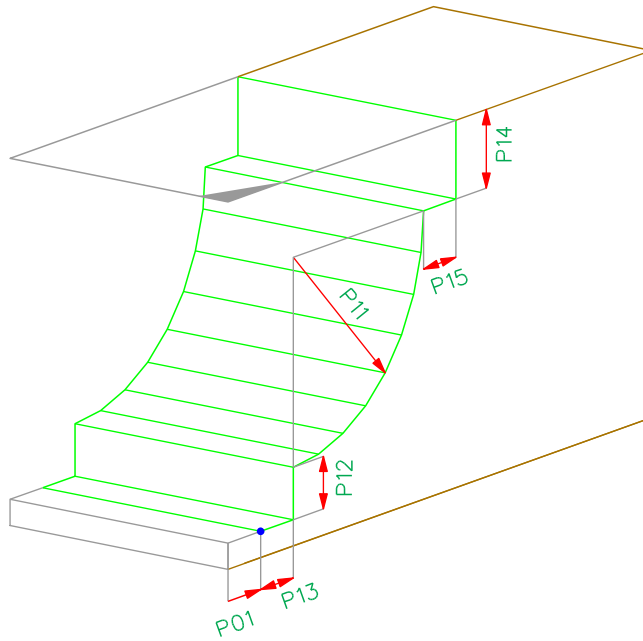

3-101-X

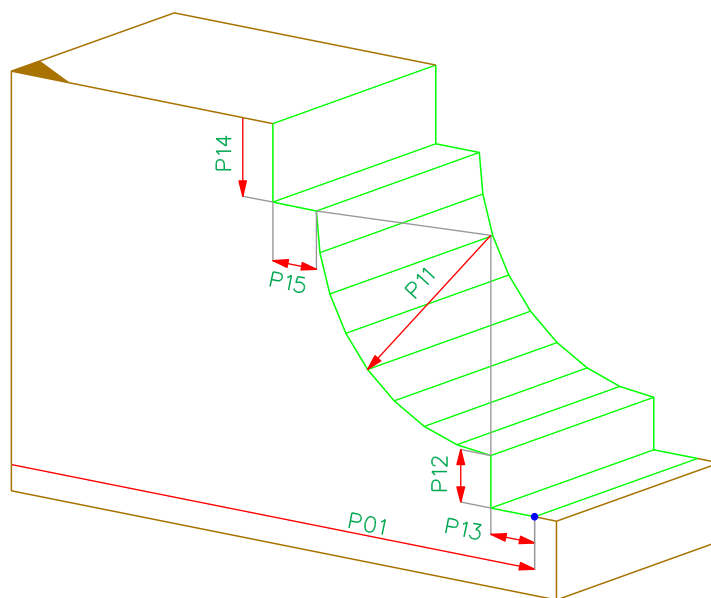

Parameters Profile Head concave

3-101-X und 4-101-X

Parameter	Min/Max	Presetting	Description
P01	+/- 99999	0	Distance from beam start to the reference point
P11	0/1000	120	Radius
P12	+/- 1000	20	Depth
P13	0/1000	20	Displacement
P14	+/- 1000	20	Depth
P15	0/1000	20	Displacement

Profile Head convex 3-102-X and 4-102-X

4-102-X

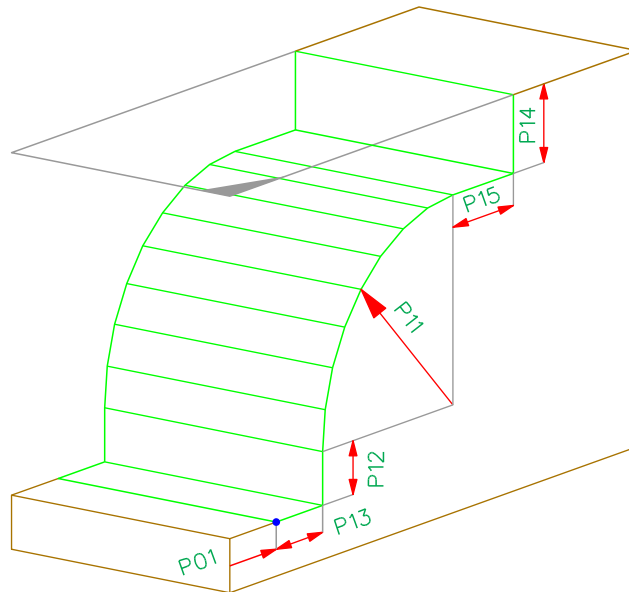

3-102-X

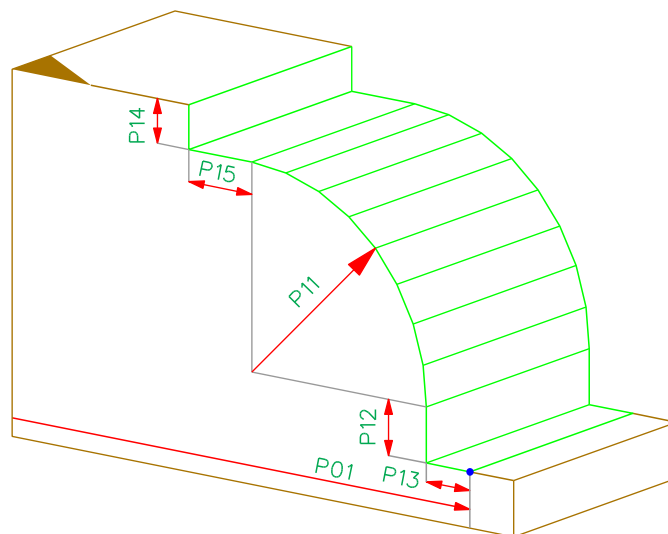

Parameters Profile Head convex

3-102-X und 4-102-X

Parameter	Min/Max	Presetting	Description
P01	+/- 99999	0	Distance from beam start to the reference point
P11	0/1000	120	Radius
P12	+/- 1000	20	Depth
P13	0/1000	20	Displacement
P14	+/- 1000	20	Depth
P15	0/1000	20	Displacement

Profile Head cambered 3-103-X and 4-103-X

4-103-X

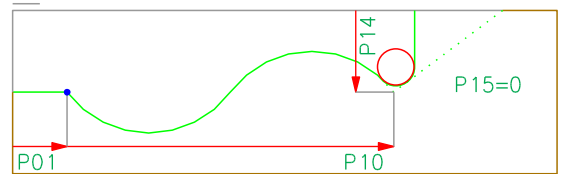
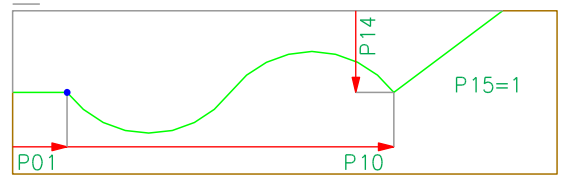
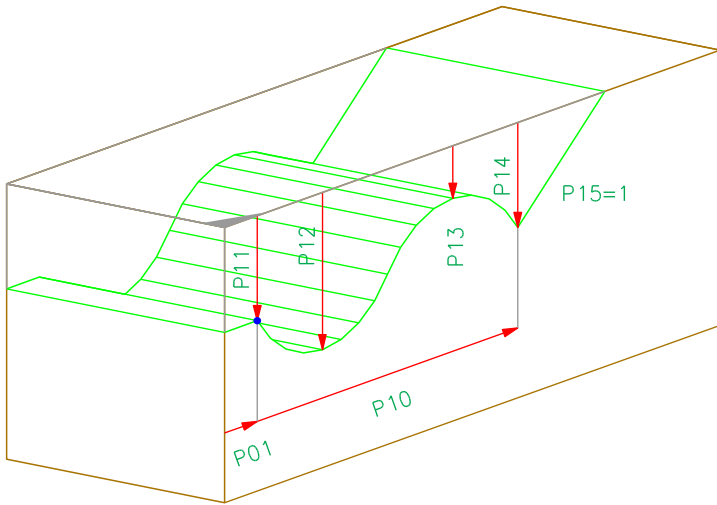

3-103-X

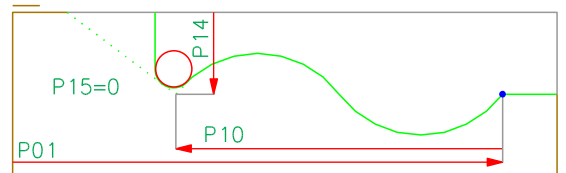
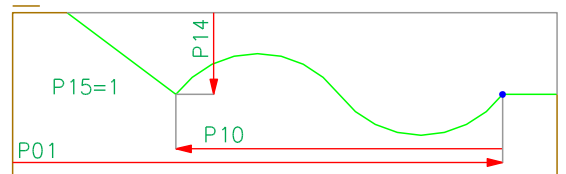
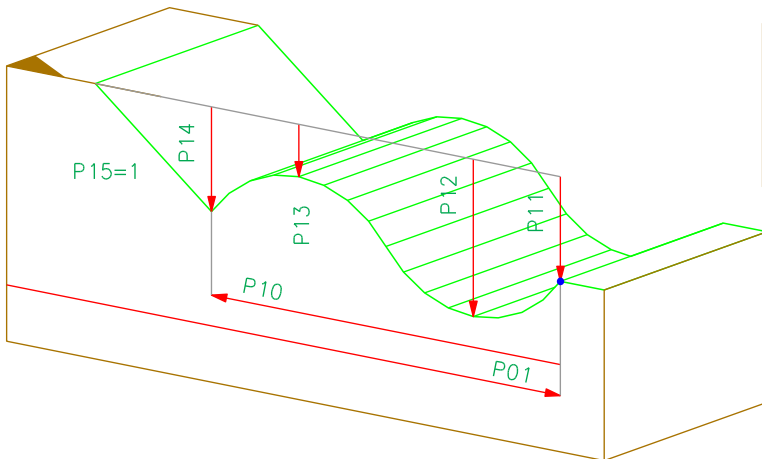

The curve is defined by a cubic polynomial.

$$Y = Ax^3 + Bx^2 + Cx + D$$

The coefficients A, B, C and D must be calculated on the machine side.

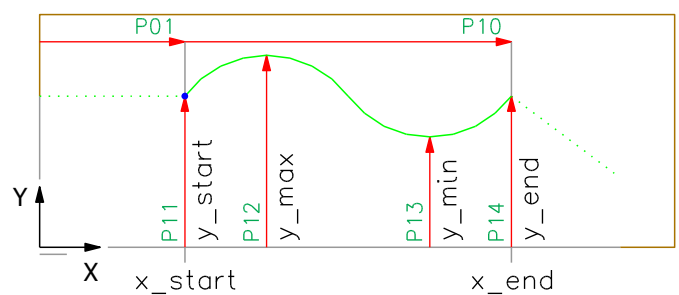

Parameters Profile Head cambered

3-103-X and 4-103-X

Parameter	Min/Max	Presetting	Description
P01	+/- 99999	0	Distance from beam start to the reference point
P10	0/50000	500	Profile length
P11	+/- 1000	40	Depth at the reference point
P12	+/- 1000	60	Maximum depth of profile
P13	+/- 1000	10	Minimum depth of profile
P14	+/- 1000	40	Depth at the profile end
P15	0/1	1	Premill: 0=round; 1=angular

Round Arch 4-104-X

4 - 104 - X

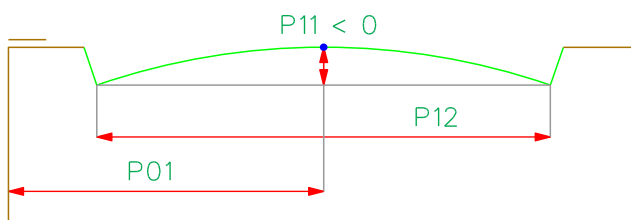
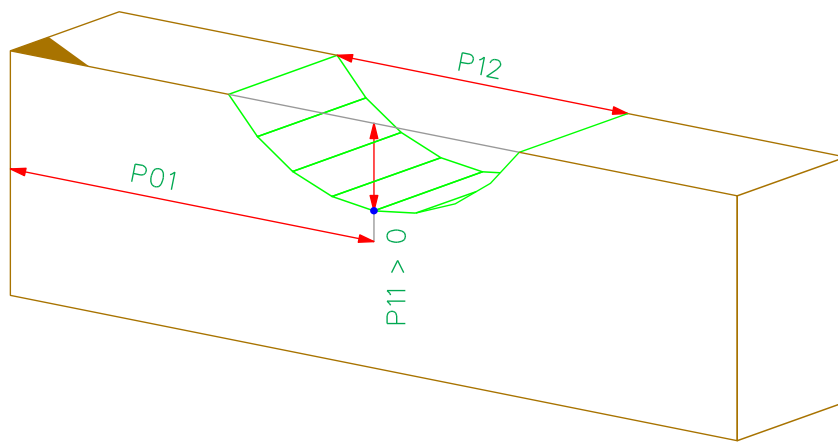

Parameters Round Arch

4-104-X

Parameter	Min/Max	Presetting	Description
P01	+/- 99999	0	Distance from beam start to the reference point
P11	+/- 1000	30	Depth of the arch segment
P12	0/30000	500	Length of the arch segment

Profile Head 3-106-X and 4-106-X

4-106-X

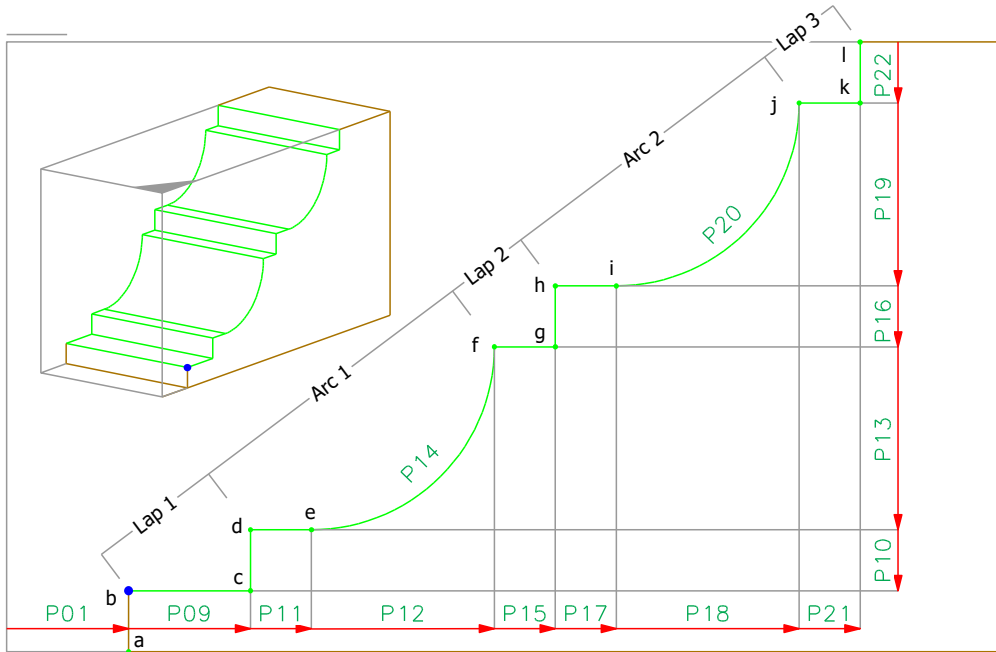

3-106-X

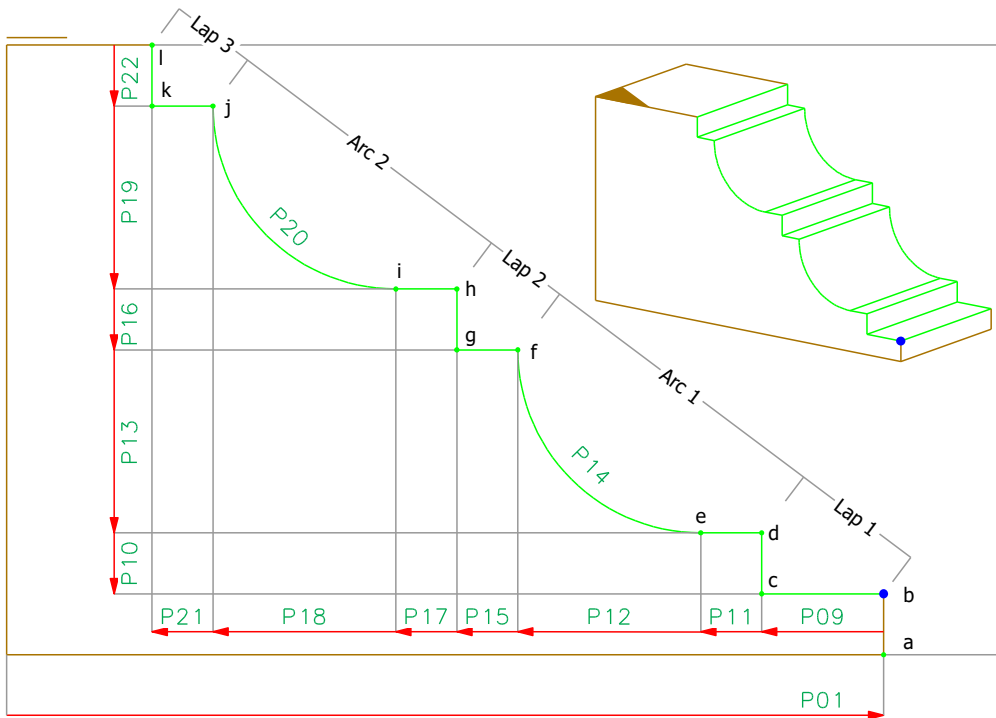

Parameters Profile Head

3-106-X und 4-106-X

Parameter	Min/Max	Presetting	Description
P01	+/- 99999	0	Distance from beam start to the reference point
P04	0/3	1	Type of arc (convex, concave), binary coded. See table below.
P09	0/1000	1/10 HRS	Length of lap 1
P10	0/1000	1/10 HRS	Depth of lap 1
P11	0/1000	1/10 HRS	Displacement arc 1
P12	0/1000	3/10 HRS	Horizontal length arc 1
P13	0/1000	3/10 HRS	Vertical length arc 1
P14	0/1000	0	Camber arc 2
P15	0/1000	1/10 HRS	Length of lap 2
P16	0/1000	1/10 HRS	Depth of lap 2
P17	0/1000	1/10 HRS	Displacement arc 2
P18	0/1000	3/10 HRS	Horizontal length arc 2
P19	0/1000	3/10 HRS	Vertical length arc 2
P20	0/1000	0	Camber arc 2
P21	0/1000	1/10 HRS	Length of lap 3
P22	0/1000	1/10 HRS	Depth of lap 3

P12=Radius
 P13=0
 P14=0

P12>0
 P13>0
 P14=>0

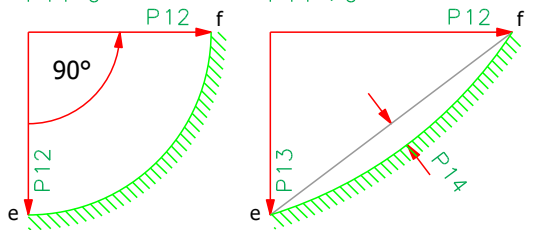

$$R = \frac{P14}{2} + \frac{s^2}{8 * P14}$$

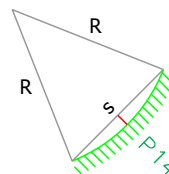

P04	Arc 1	Arc 2
0		
1		
2		
3		

The definition for P18, P19, P20, i, j is similar to P12, P13, P14, e, f.

Sphere 3-107-X and 4-107-X

4-107-X

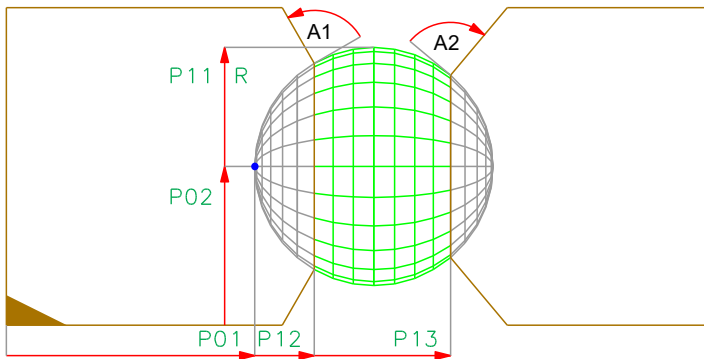

A1: Angle between tangent on sphere and limit face at P12.
 A2: Angle between tangent on sphere and limit face at P13.
 A1 and A2 are defined on the machine side. They depend on the capabilities of the machine.
 In this pictures A1 and A2 are 90° .

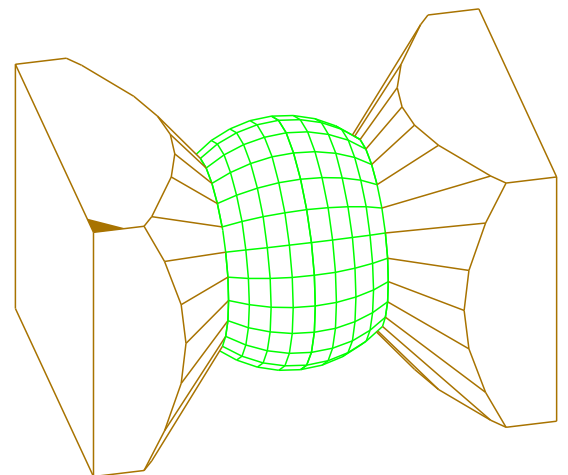
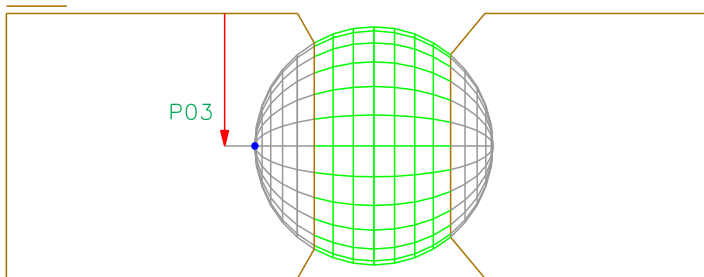

3-107-X

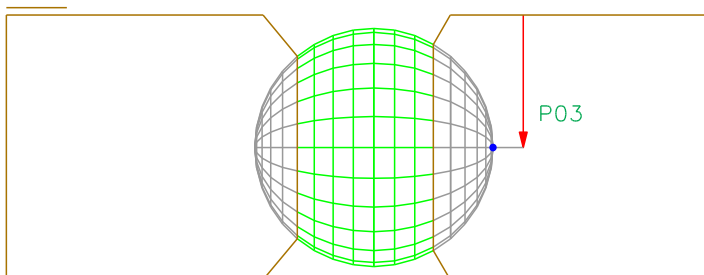
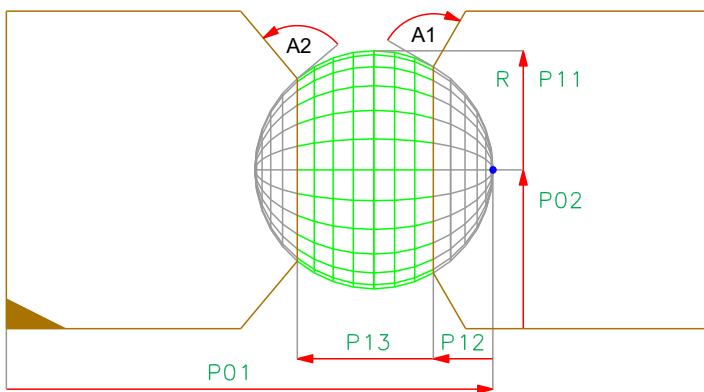

Parameters Sphere

3-107-X and 4-107-X

Parameter	Min/Max	Presetting	Description
P01	+/- 99999	0	Distance from beam start to the reference point
P02	+/- 99999	WRS / 2	Distance from the reference edge to the reference point
P03	+/- 99999	HRS / 2	Distance from the reference side to the reference point
P11	+/- 99999	WRS / 2	Radius
P12	0/99999	0	Start offset
P13	0/99999	P11	Length

Triangle Cut 4-120-X

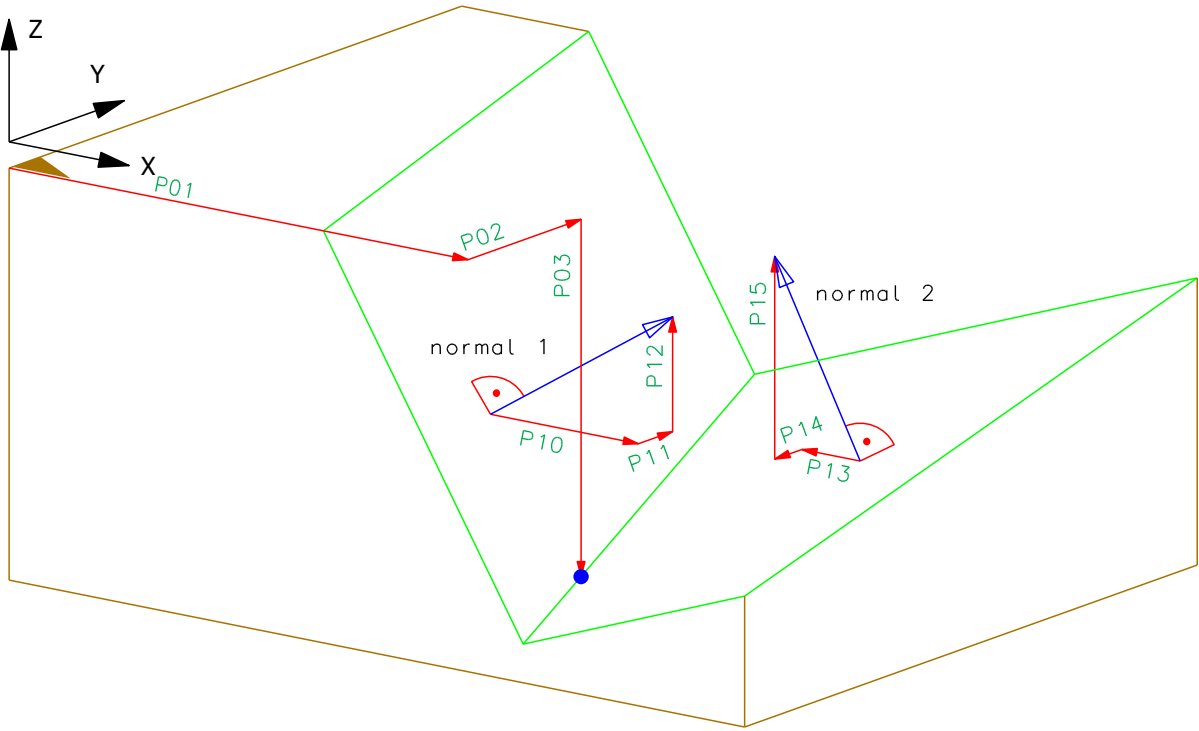

Parameters Triangle Cut

4-120-X

Parameter	Min/Max	Presetting	Description
P01	+/- 99999	0	Distance from beam start to the reference point
P02	+/- 50000	0	Distance from the reference edge to the reference point
P03	+/- 50000	0	Distance from the reference side to the reference point
P10	+/- 50000	1	Normal vector 1: Length of X-component
P11	+/- 50000	0	Normal vector 1: Length of Y-component
P12	+/- 50000	1	Normal vector 1: Length of Z-component
P13	+/- 50000	-1	Normal vector 2: Length of X-component
P14	+/- 50000	0	Normal vector 2: Length of Y-component
P15	+/- 50000	1	Normal vector 2: Length of Z-component

Tyrolean Dovetail 1/2/3/4-136-X

2/4-136-X

P04=1 P06=90° P07=0 P08=0 P12=0 P13=0

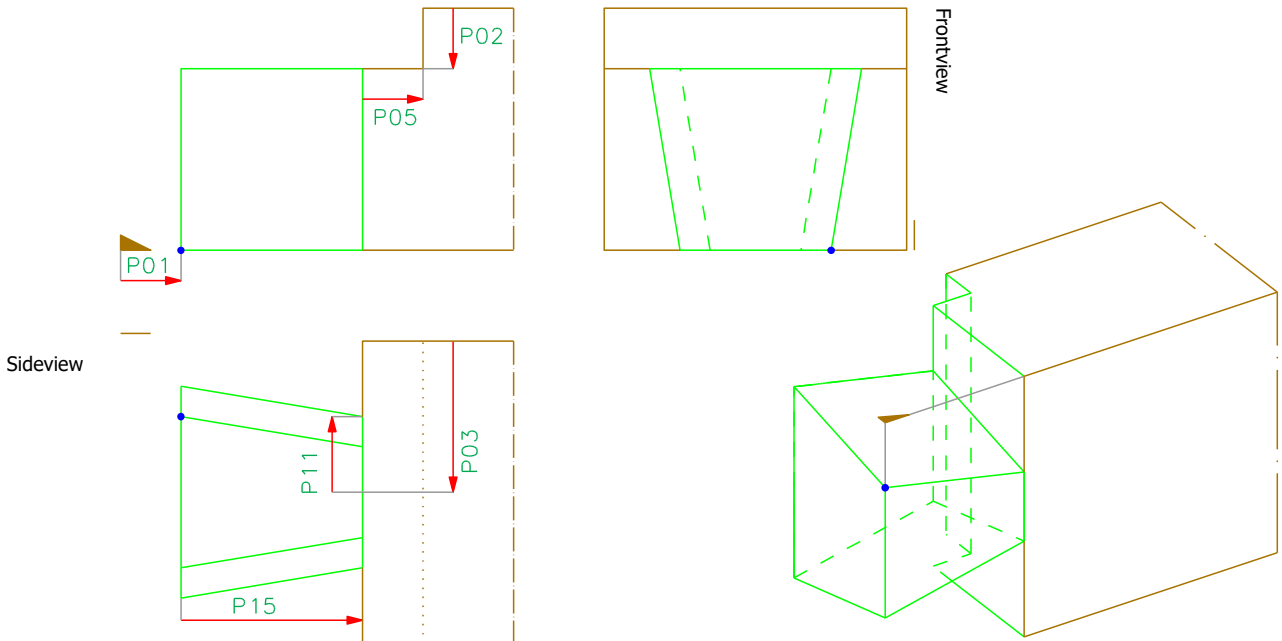

P04=0 P06=90° P07=0 P08=0 P12=0 P13=0

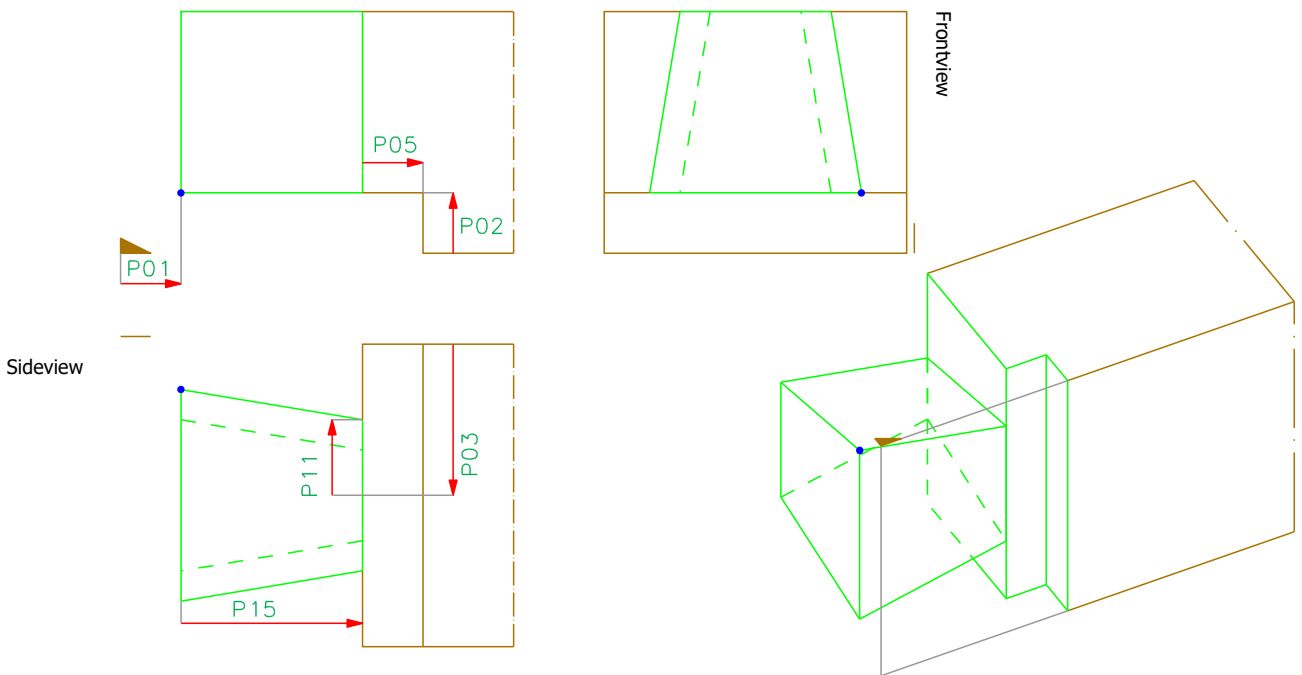

2-136-X

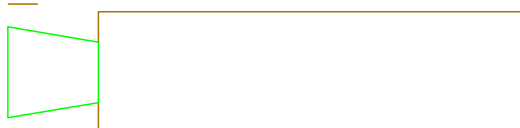

4-136-X

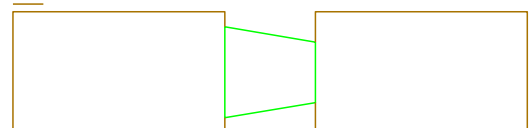

Tyrolean Dovetail 1/2/3/4-136-X

2/4-136-X

P04=1 P06<>90° P07=0 P08=0
P12=0 P13=0

P04=0 P06<>90° P07=0 P08=0
P12=0 P13=0

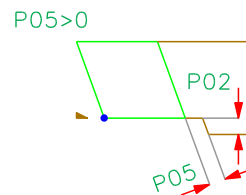
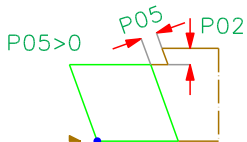
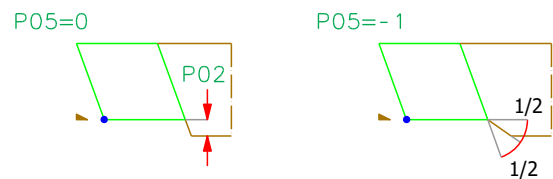
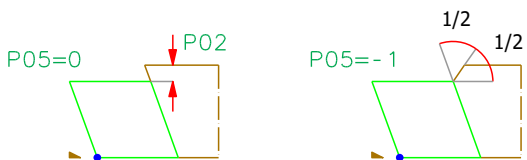
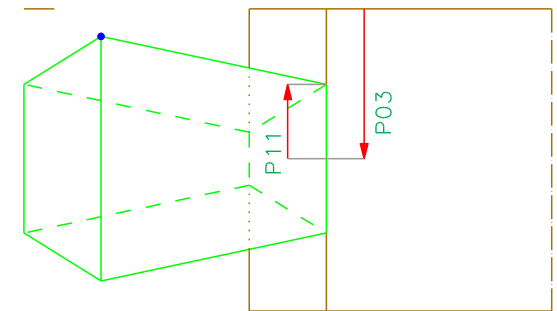
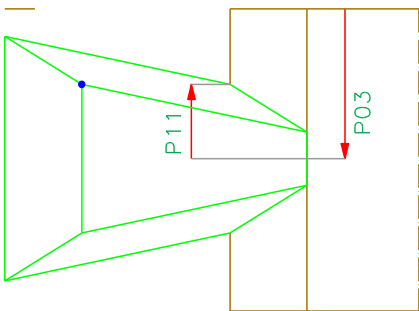
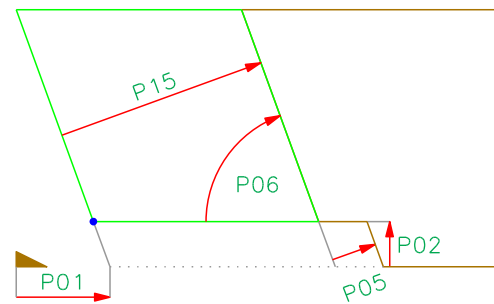
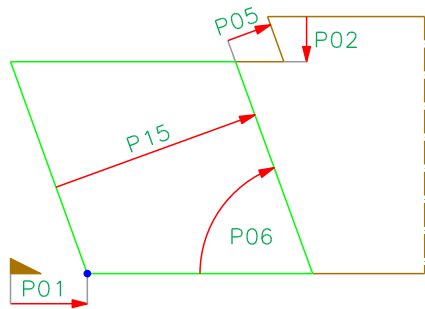
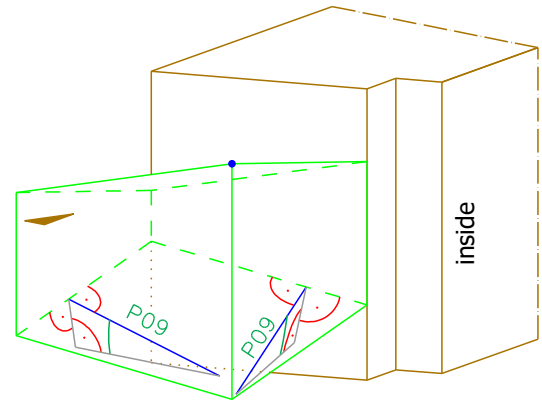
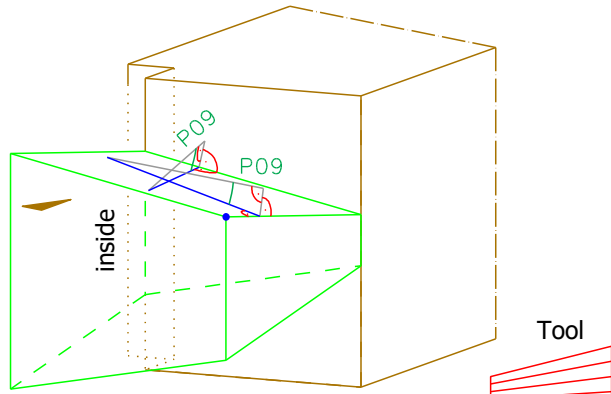

Tyrolean Dovetail 1/2/3/4-136-X

2/4-136-X

P04=1 P06=90° P07>0 P08>0 P12=0 P13=0

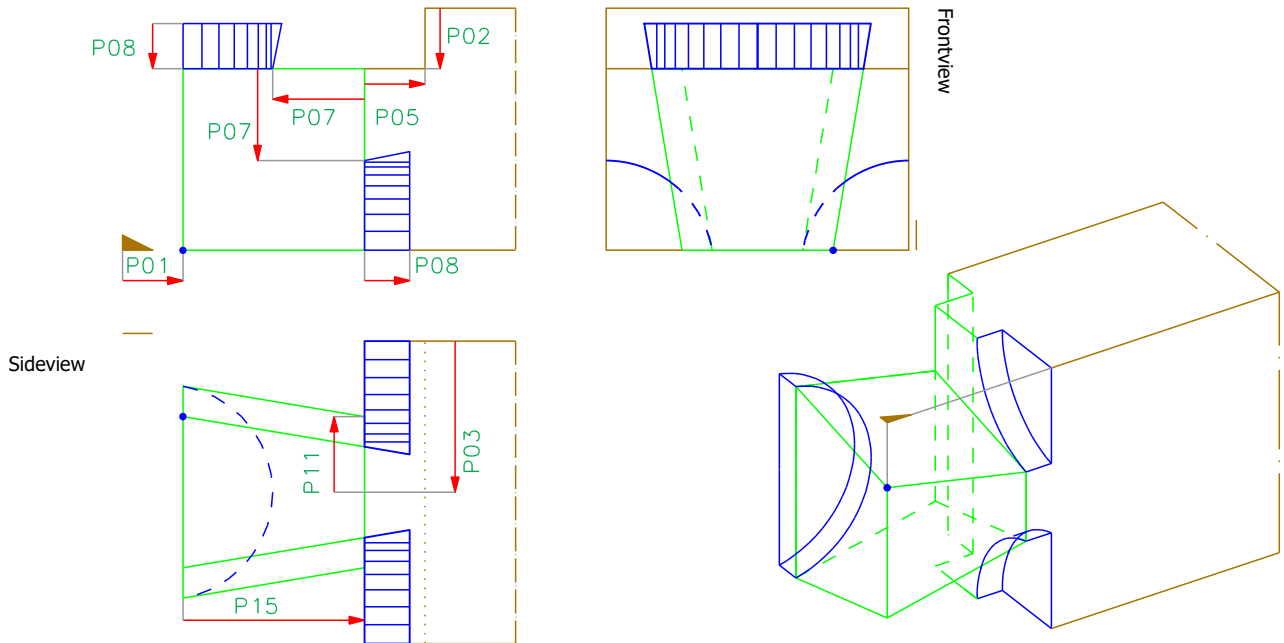

P04=0 P06=90° P07>0 P08>0 P12=0 P13=0

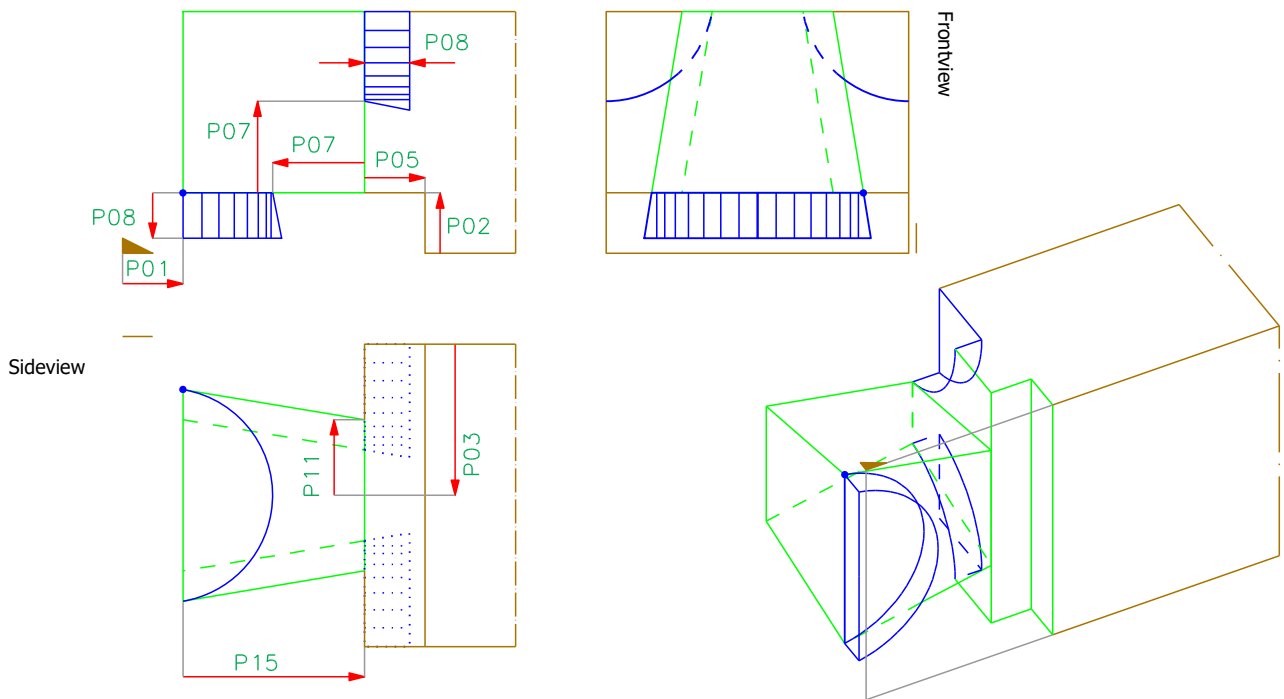

Tyrolean Dovetail 1/2/3/4-136-X

2/4-136-X

$P04=1$ $P06=90^\circ$ $P07=0$ $P08=0$ $P12>0$ $P13>0$

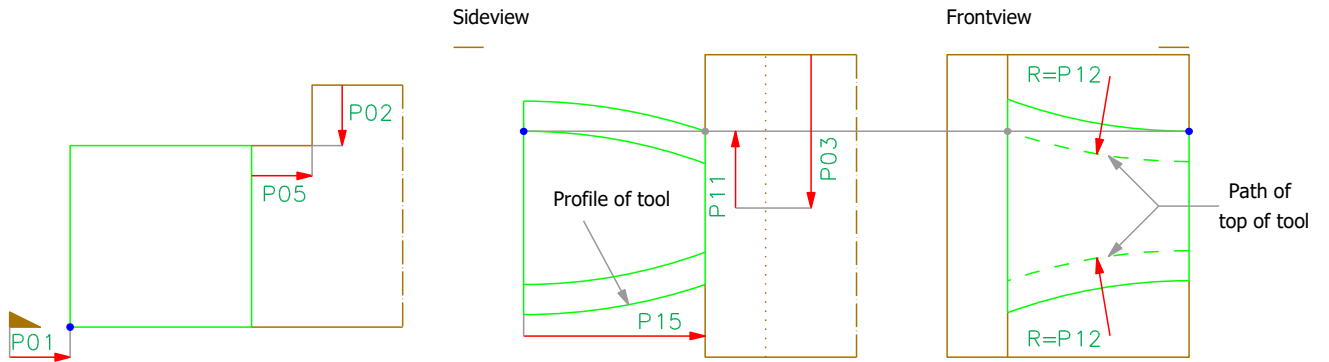

$P04=0$ $P06=90^\circ$ $P07=0$ $P08=0$ $P12>0$ $P13>0$

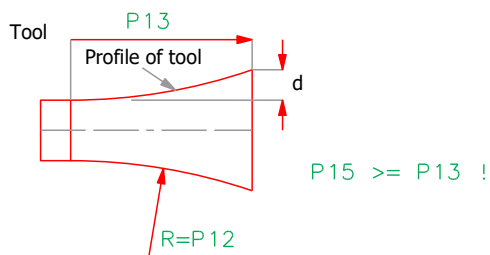
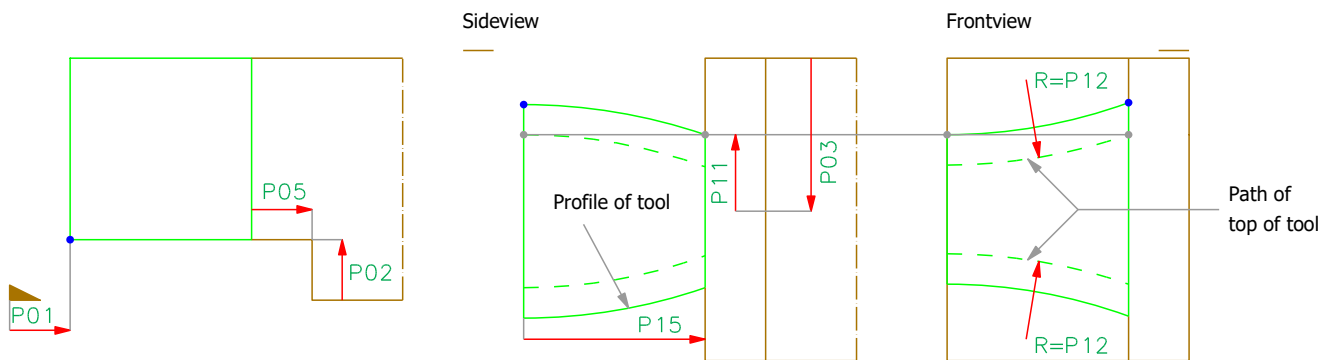

Tyrolean Dovetail 1/2/3/4-136-X

1/3-136-X

P04=1 P06=90° P07=0 P08=0 P12=0 P13=0

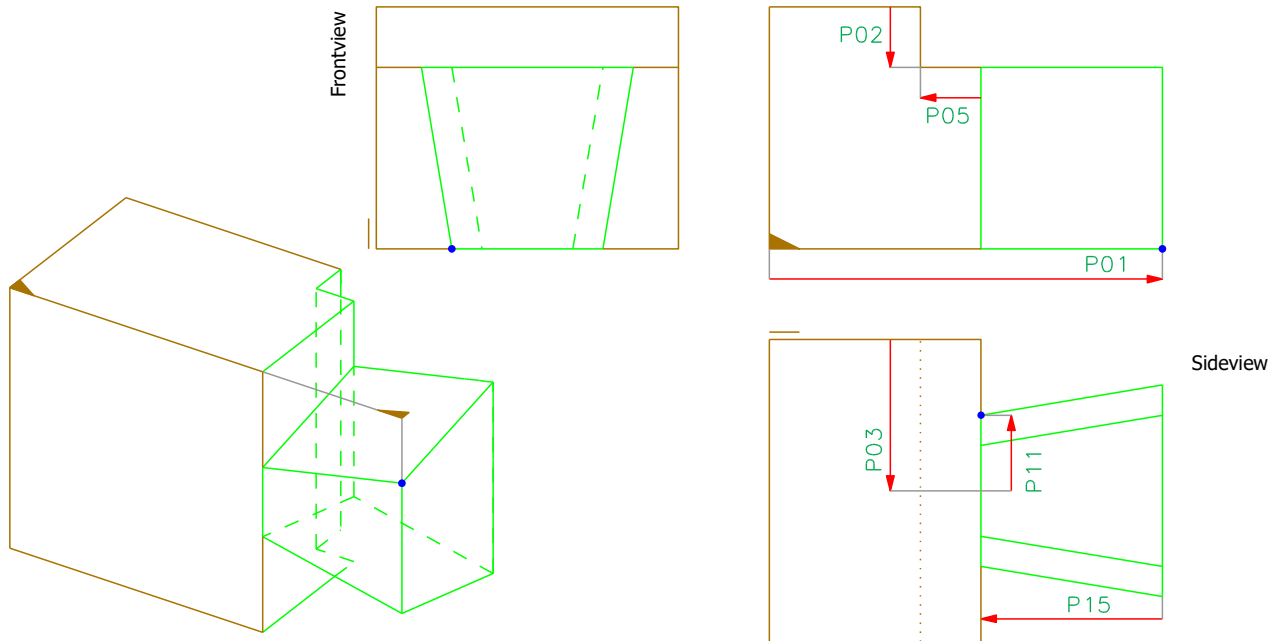

P04=0 P06=90° P07=0 P08=0 P12=0 P13=0

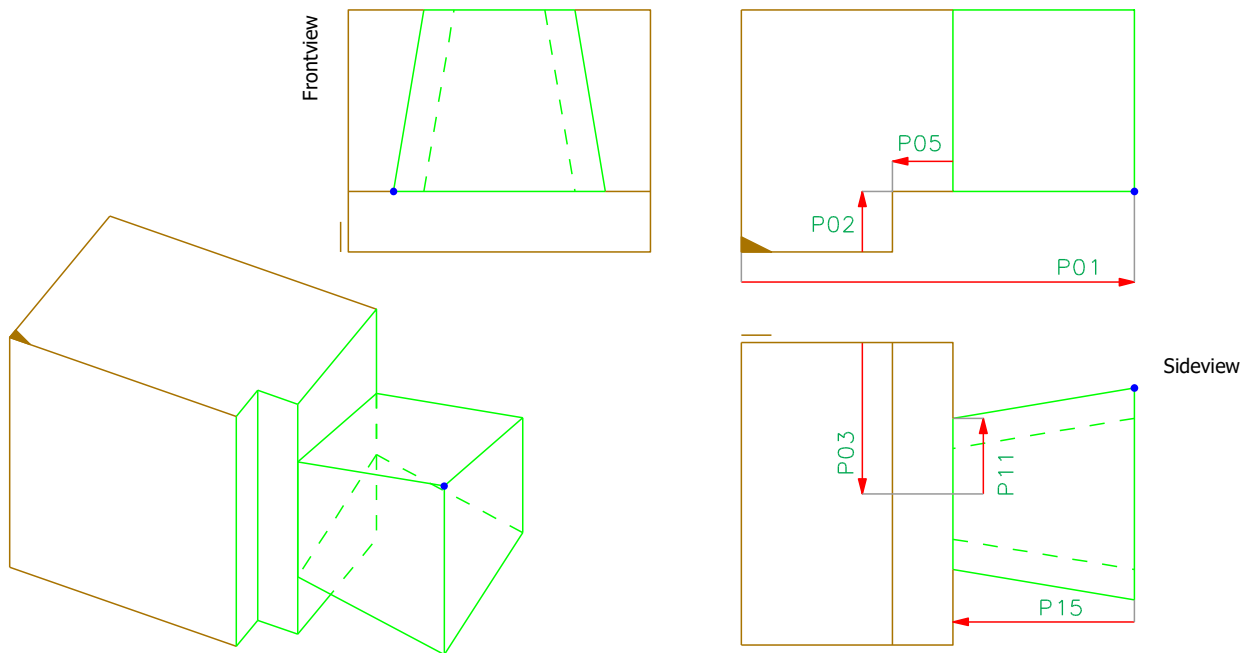

1-136-X

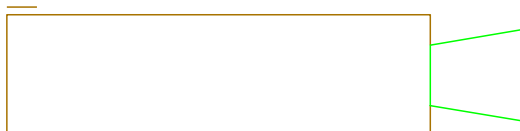

3-136-X

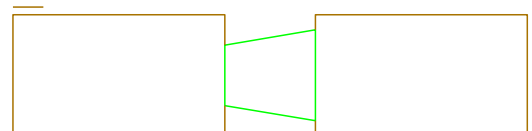

Tyrolean Dovetail 1/2/3/4-136-X

1/3-136-X

P04=1 P06<>90° P07=0 P08=0
P12=0 P13=0

P04=0 P06<>90° P07=0 P08=0
P12=0 P13=0

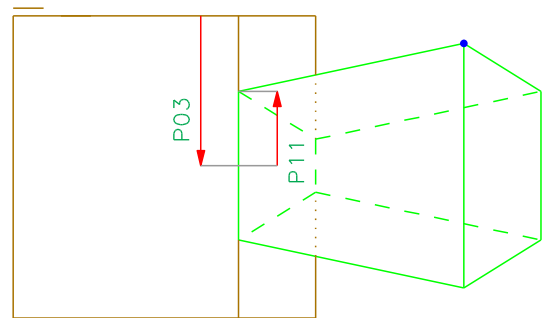
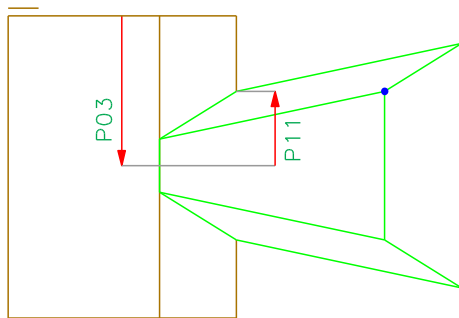
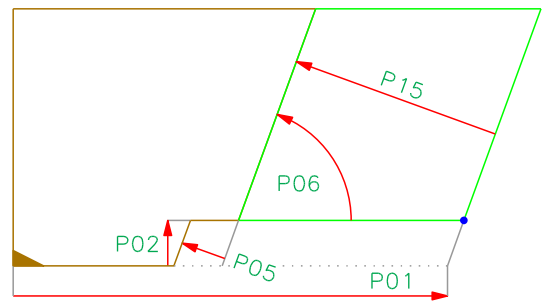
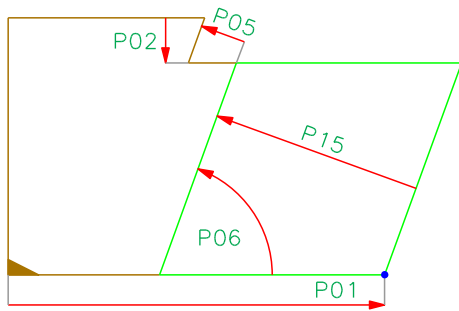
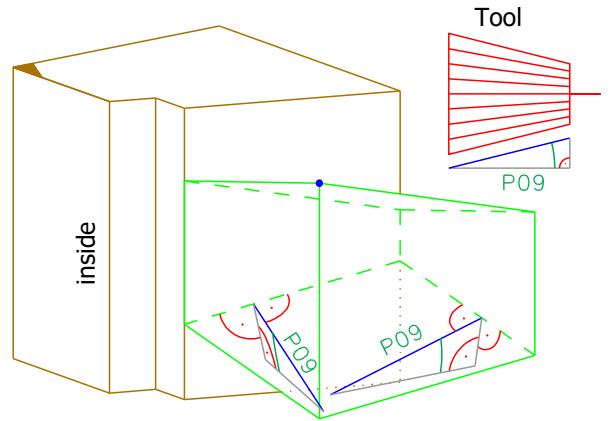
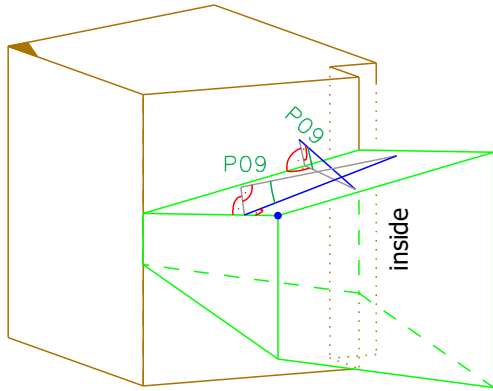

P05=0

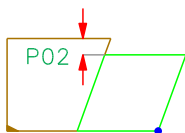

P05=-1

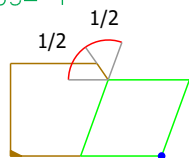

P05>0

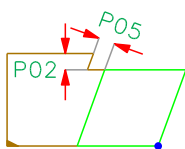

P05=0

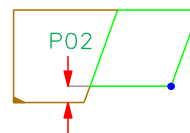

P05=-1

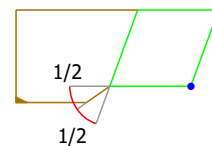

P05>0

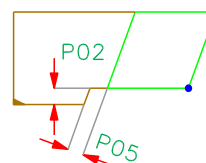

Tyrolean Dovetail 1/2/3/4-136-X

1/3-136-X

P04=1 P06=90° P07>0 P08>0 P12=0 P13=0

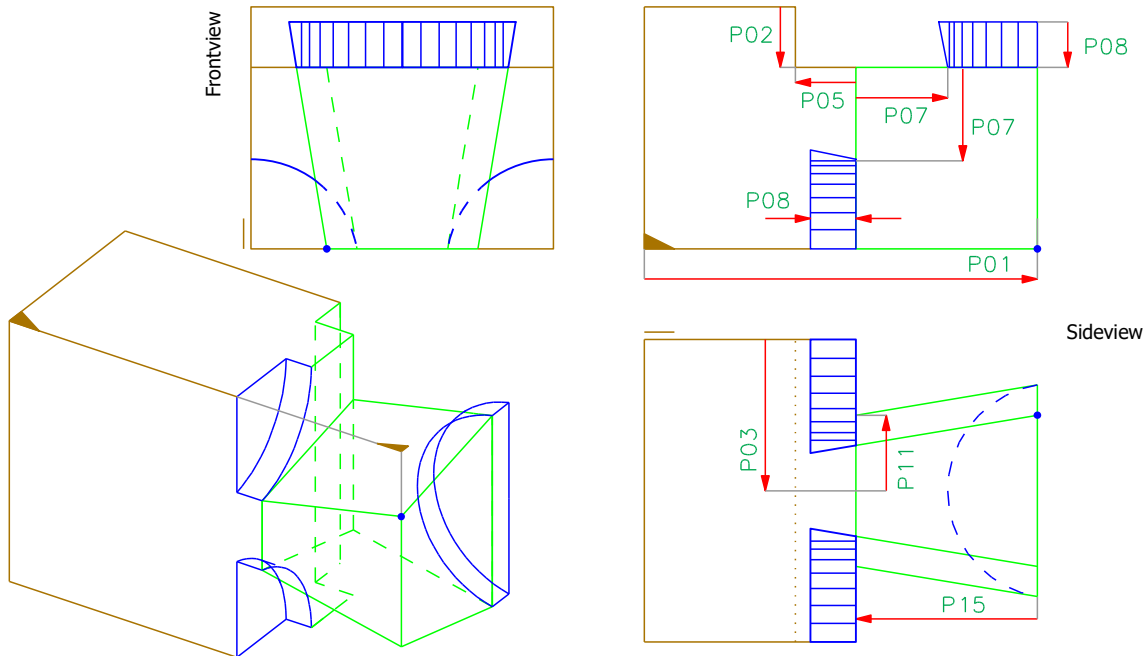

P04=0 P06=90° P07>0 P08>0 P12=0 P13=0

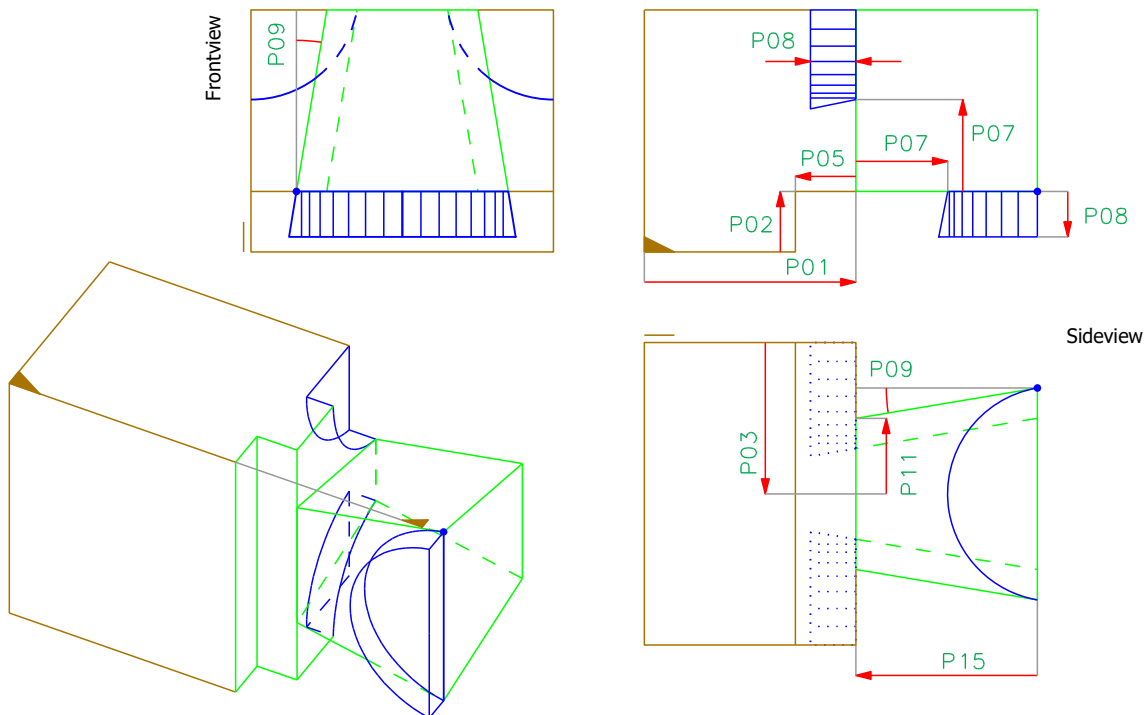

Tyrolean Dovetail 1/2/3/4-136-X

1/3-136-X

$P04=1$ $P06=90^\circ$ $P07=0$ $P08=0$ $P12>0$ $P13>0$

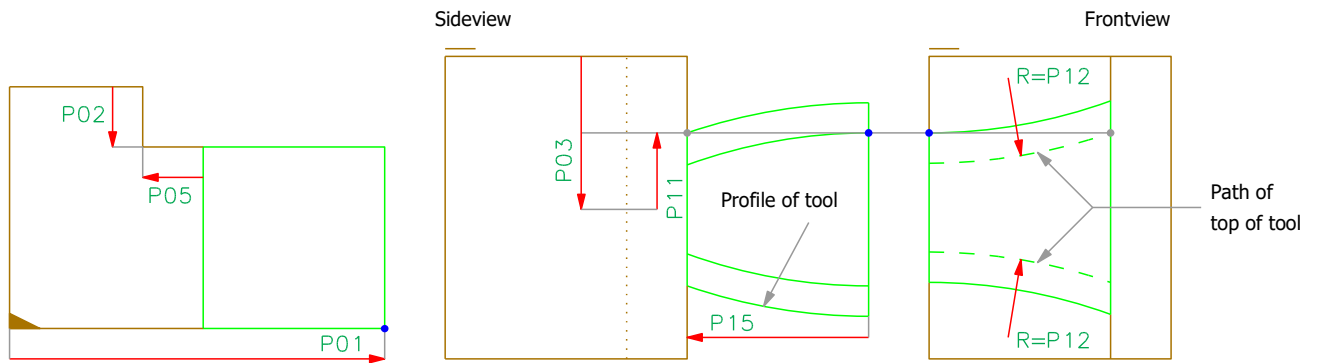

$P04=0$ $P06=90^\circ$ $P07=0$ $P08=0$ $P12>0$ $P13>0$

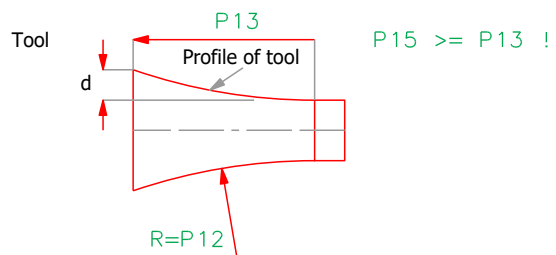
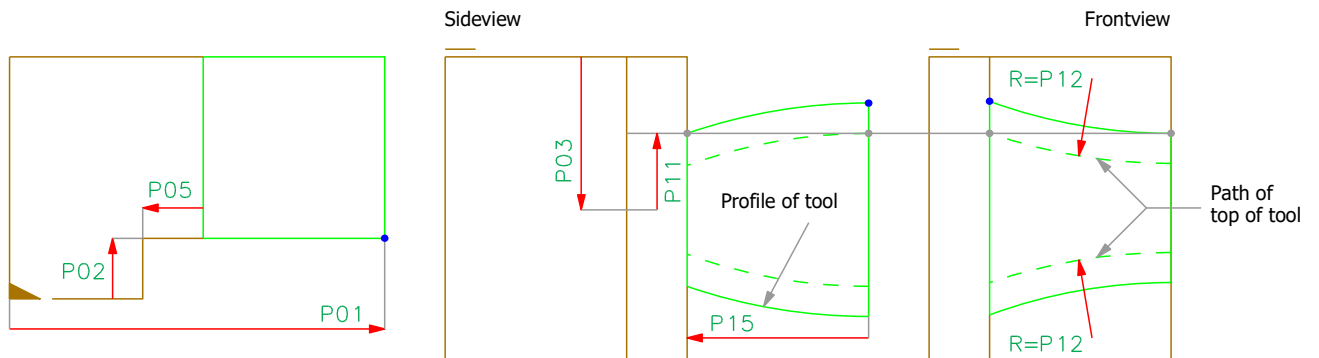

Tyrolean Dovetail

1/2/3/4-136-X

Parameter	Min/Max	Presetting	Description
P01	+/- 99999	0	Distance from beam start to the reference point
P02	0/50000	30	Distance between "inside" an side of part
P03	+/- 50000	HRS/2	Distance orthogonal to the reference side
P04	0/1	0	0: "inside" at reference edge, 1: "inside" at opposite of reference edge
P05	-1/0/50000	0	0: Without rebate or mitre -1: With mitre >0: With rebate
P06	1/179	90	Angle to the reference edge in the reference side
P07	0/50000	0	Width
P08	0/50000	0	Depth
P09	0/45	15	Inclination
P11	0/50000	0.25 x HRS	Height
P12	0/50000	0	Radius
P13	0/50000	0	Length of tool (part of arc)
P14	0/1	0	0: Angular corner joint 1: Straight T-wall connection
P15	0/50000	WRS	Length
P16			0: Processing on the reference side and opposite the reference side 1: Processing only on the reference side 2: Processing only opposite the reference side

Dovetail 1/2/3/4-138-X

2/4-138-X

Dovetail 1/2/3/4-138-X

1/3-138-X

	P04=1	P04=0
P14=0		
P14=1		
P05	<p>P05=0</p> <p>P05=-1</p> <p>P05>0</p>	<p>P05=0</p> <p>P05=-1</p> <p>P05>0</p>

Dovetail

1/2/3/4-138-X

Parameter	Min/Max	Presetting	Description
P01	+/- 99999	0	Distance from beam start to the reference point
P02	0/50000	30	Distance between "inside" an side of part
P03	+/- 50000	HRS/2	Distance orthogonal to the reference side
P04	0/1	0	0: "inside" at reference edge, 1: "inside" at opposite of reference edge
P05	-1/0/50000	0	0: Without rebate or mitre -1: With mitre >0: With rebate
P09	0/45	15	Inclination
P11	0/50000	0.333 x HRS	Depth 1
P12	0/50000	0.167 x HRS	Depth 2
P14	0/1	0	0: European Dovetail 1: American Dovetail
P15	0/50000	WRS	Length
P16			0: Processing on the reference side and opposite the reference side 1: Processing only on the reference side 2: Processing only opposite the reference side

P16=0

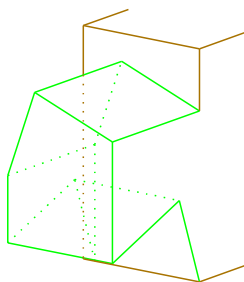

P16=1

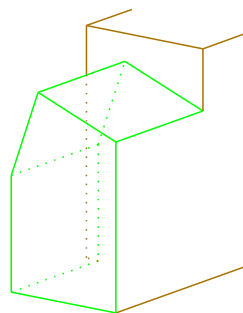

P16=2

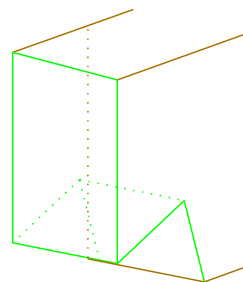

Free Contour 0-250-X, 3-250-X, 4-250-X

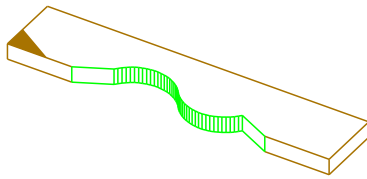

3-250-X Toolpath to the left of the contour

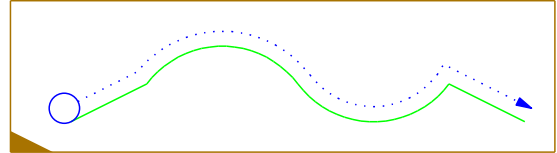

0-250-X Toolpath on contour

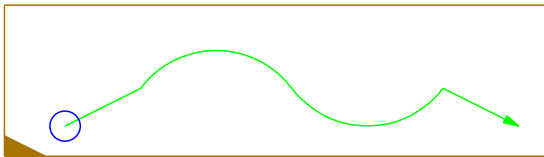

4-250-X Toolpath to the right of the contour

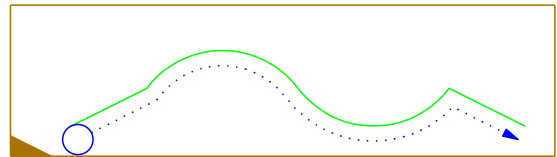

example

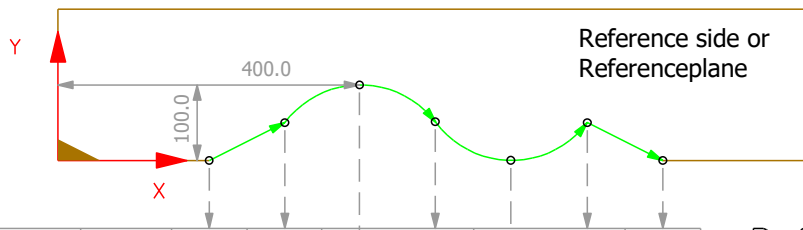

4-250-X

PROCESSIDENT		1	2	3	4	5	
Typ	P08	0	1	2	2	1	
Next Segment	P09	2	3	4	5	0	
Endpoint	X	P01	200.0	300.0	500.0	700.0	800.0
	Y	P02	0.0	50.0	50.0	50.0	0.0
	Z	P03	0.0	0.0	0.0	0.0	0.0
Point on arc	X	P10			400.0	600.0	
	Y	P11			100.0	0.0	
	Z	P12			0.0	0.0	

Referenceplane

If the contour has a REFERENCE-PLANE, then the REFERENCEPLANE of the first segment (STARTPOINT) is used for the whole contour, for all other segments.

Inclination P06

In this view the contour is oriented away from the observer.

3-250-X

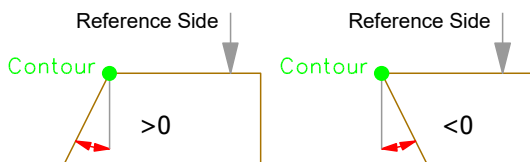

4-250-X

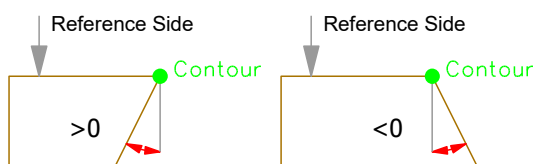

The inclination is constant over the length of the segment and is always measured from the tangent of the contour at the actual point.

If inclination is not set at a segment, then inclination of the startpoint is valid for the segment.

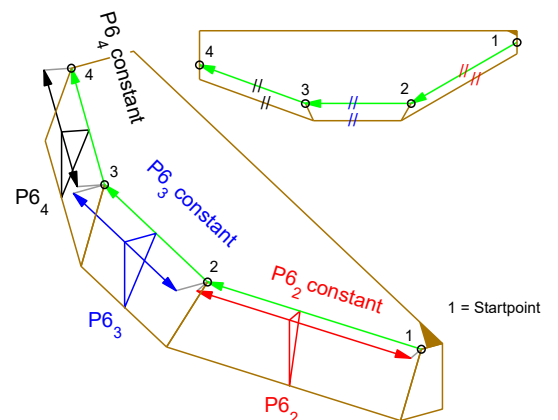

Parameters Free Contour

0-250-X, 3-250-X, 4-250-X

Segment type	Startpoint P08=0	Startpoint P08=100 There is an associated contour existing.	Startpoint P08=101 This is an associated contour to a contour P08=100	Straight Line P08=1	Arc P08=2
P08					
P01 P02 P03	Start-point x y z	Start-point x y z	Start-point x y z	End-point x y z	End-point x y z
P05	Depth (≥ 0) 0: complete HRS				
P06	Inclination Valid for all segments, if it is not specified at a segment himself. Min/Max=-/+89.9 Presetting=0	Processident of contour 101	Processident of contour 100	Inclination (only for this segment) No meaning, if this segment is - part of contour, which has an associated contour or is - part of an associated contour Min/Max=-/+89.9 Presetting=0	
P07	Mode: 0=contour only, 1=countersink completely. Only for closed contours. Only for Free- and Mill Contour.				
P08	See headline in this table				
P09	Processident of following segment. 0 means, there is no further segment.				
P10 P11 P12					Point on arc x y z
P13	Contour type				
P14	Parameter depends on contour type (P13)				
P15	Parameter depends on the Contour type (P13). See details in the table for P13, P14 and P15.		Parameter depends on the Contour type (P13). See details in the table for P13, P14 and P15.		

The distance between start- and endpoint in a segment can be 0.

Depth P03, P05

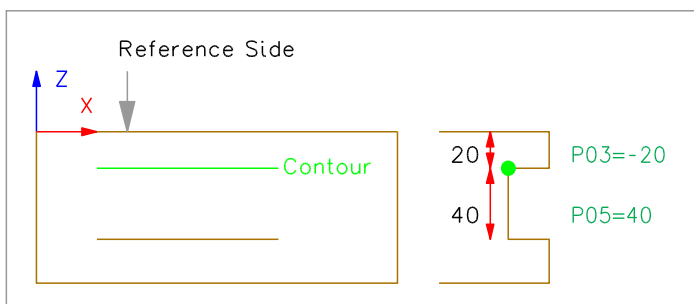

Circle

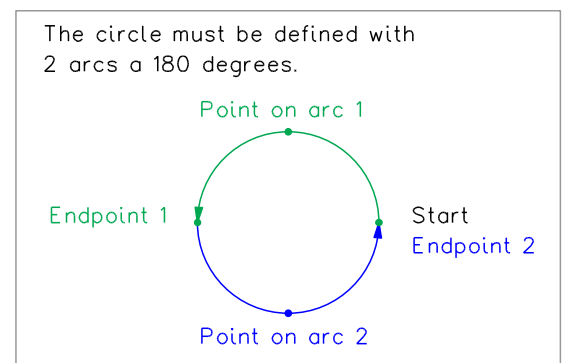

Contour with an associated contour

Upper line: Pt1 to Pt4

Lower line: Pt5 to Pt8 (associated contour)

The contour and its associated contour are defined on the same referenceside.

The contour and the associated contour are connected via the processidents of their respective starting points. The parameter P06 of the starting point of the contour (P08=100) references the associated contour, whereas the parameter P06 of the starting point of the associated contour (P08=101) references the contour.

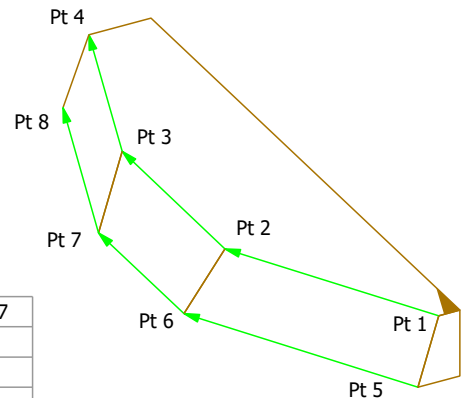

PROCESSIDENT		70	71	72	73	74	75	76	77
Typ	P08	100	1	1	1	101	1	1	1
Next Segment	P09	71	72	73	0	75	76	77	0
Associated contour	P06	74	--	--	--	70	--	--	--
Endpoint	P01/P02/P03	Pt 1	Pt 2	Pt 3	Pt 4	Pt 5	Pt 6	Pt 7	Pt 8

Processing Attributes

The processing attributes REFERENCEPLANE, PROCESSINGQUALITY, PRIORITY, RECESS P15 (Saw and Mill) and PROCESS may only be defined in the first segment (startpoint) of the contour, they are valid for the whole contour.

0=contour only, 1=countersink

Contour types and the according parameters P13, P14 and P15

Contour type	P13	P14	P15	Comment
Free contour	0	Tool ID		
Saw contour	1	Tool ID	Recess	P15 is allowed for all segment types
Mill contour	2	Tool ID	Recess	P15 is allowed for all segment types
Pen contour	10	Tool ID		P05 is ignored
Nail (screw) contour	20	Tool ID	Nail spacing	P05 is ignored P15 is allowed for all segment types
Glue area	30	Tool ID		P07 must be 1 P05 is ignored
Planing area	40	Tool ID		P07 must be 1
Plaster area	50	Tool ID		P07 must be 1
Lock-out area	200	Type of lock-out area, bit coded. P14 =0: for all contour processings Bit 1=1 (1): for nailing Bit 2=1 (2): for glueing Bit 3=1 (4): for planing Bit 4=1 (8): for plastering Bit 5=1 (16): for free contour Bit 6=1 (32): for saw contour Bit 7=1 (64): for mill contour Bit 8=1 (128): for pen contour		P07 must be 1 P05 is ignored

If no Tool ID is specified, the machine has to select a tool.

If P15 is defined for the startpoint, its value is valid for the whole contour.

If P15 is defined in a following segment, it overrides the P15 of the startpoint only for this segment.

Nail (screw) contour (P13=20)

If Nail spacing (P15) fits not to the length of a segment, then the spacing can be defined on the machine side.

Proposal: New spacings (<= P15) with equidistance.

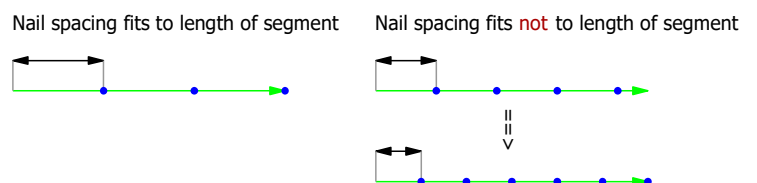

P15 Recess for Saw contour (P13=1) and Mill contour (P13=2)

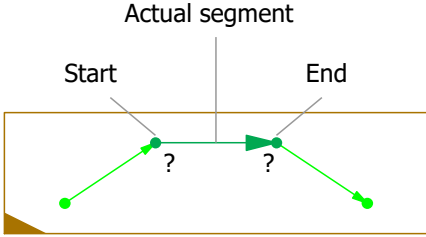
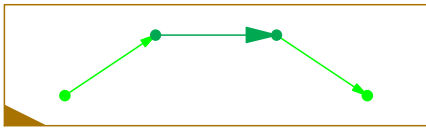
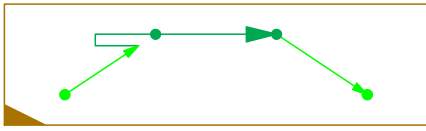
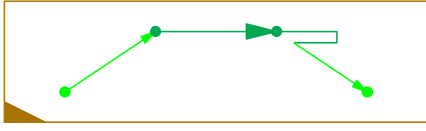
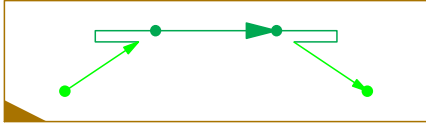
P15	
0	<p>The processing at the vertexes has to be specified by the machine</p> 
1	<p>Do not pass over</p> 
2	<p>Pass over at start</p> 
3	<p>Pass over at end</p> 
4	<p>Pass over at start Pass over at end</p> 

The machineside decides, how the RECESS is worked out. Examples:

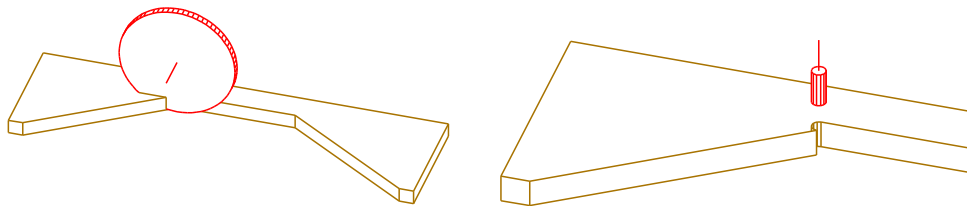

Referenceplane

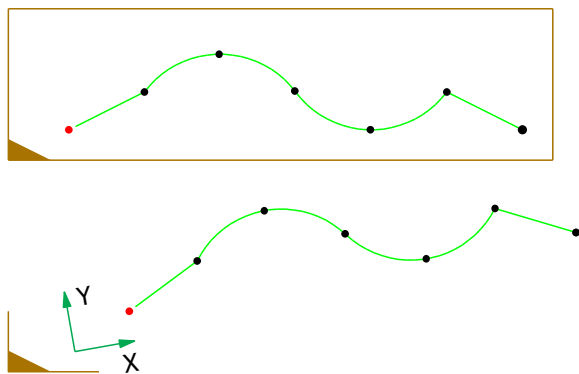

If the contour has a REFERENCEPLANE, then only the REFERENCEPLANE of the first segment (Startpoint) is used for the whole contour, for all other segments.

Variant 0-900-X, 1-900-X, 2-900-X, 3-900-X, 4-900-X

With this type the user can define his own processings. In addition to the parameters of a processing he has to specify the machining by an Integer value in the PROCESSKEY line.

Example:

```
PROCESSKEY: 4-900-2      4711  
COMMENT: "MyProcess"
```

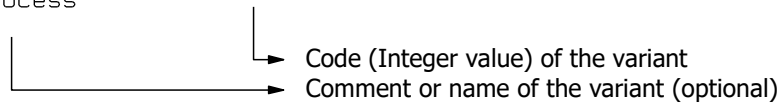

The parameters P01 to P15 can be used to describe the processing.

In order to avoid numbering conflicts and ensure interoperability of variants of different manufacturers, variants should be sent to design2machine. They will then be published on the design2machine homepage and will eventually be defined as a standard processing in a later BTL version.

Parameters Variant

0-900-X, 1-900-X, 2-900-X, 3-900-X, 4-900-X

Parameter	Min/Max	Presetting	Description
P01	+/- 99999	0	user definded
P02	+/- 99999	0	user definded
P03	+/- 99999	0	user definded
P04	+/- 99999	0	user definded
P05	+/- 99999	0	user definded
P06	+/- 99999	0	user definded
P07	+/- 99999	0	user definded
P08	+/- 99999	0	user definded
P09	+/- 99999	0	user definded
P10	+/- 99999	0	user definded
P11	+/- 99999	0	user definded
P12	+/- 99999	0	user definded
P13	+/- 99999	0	user definded
P14	+/- 99999	0	user definded
P15	+/- 99999	0	user definded

7. Prefabrication

This chapter summarizes the extensions for the construction of prefabricated houses.

Identification Index	Datatypes	Meaning
<i>Loop over the parts</i> [PART] ... <i>End of loop over the parts</i>		
<i>Loop over the composites</i> [COMPOSITE]		
<p>The composite has the same attributes as a part. It further has an attribute TYPE (see below). Composites are virtual building blocks, they simplify the composition in the prefabrication process. Each type of composite is optional, i.e. each combination of composites can be used as required by the prefabrication process.</p> <p>Each ELEMENT must have a REFERENCESIDE and a Layer 0. The Layer numbers must be without gap. The composite types have a hierarchical ordering:</p>		
TYPE:	MODULE	A composite of type MODULE can contain: Parts and processings.
	LAYER	A composite of type LAYER can contain: Composites of type MODULE, parts and processings.
	ELEMENT	A composite of type ELEMENT can contain: Composites of type MODULE, LAYER, parts and processings.
	ELEMENTCHARGE	A composite of type ELEMENTCHARGE can contain: Composites of type MODULE, LAYER, ELEMENT, parts and processings.
<p>In the btl file, the composites should be arranged in the order of the types, i.e. first all composites of type MODULE, then all of type LAYER, then all of type ELEMENT and last all of type ELEMENTCHARGE.</p>		
<i>Loop over the processings for a composite</i>		
PROCESSKEY:	0-300-0	With this key a part or a composite is set to the composite. Subpart refers to the coordinate-system of the superior composite.
REFERENCEPLANE:	OX: Parameter type OY: Parameter type OZ: Parameter type XX: Parameter type XY: Parameter type XZ: Parameter type YX: Parameter type YY: Parameter type YZ: Parameter type	Coordinate triple origin of the part-coordinate-system Direction vector of the local x axis Direction vector of the local y axis
PROCESSPARAMETERS:	UID: Integer	UID of the transformation of the part or composite
<i>End of loop over the processings for composite</i>		
<i>End of loop over the composites</i>		

Listing in the BTL-File

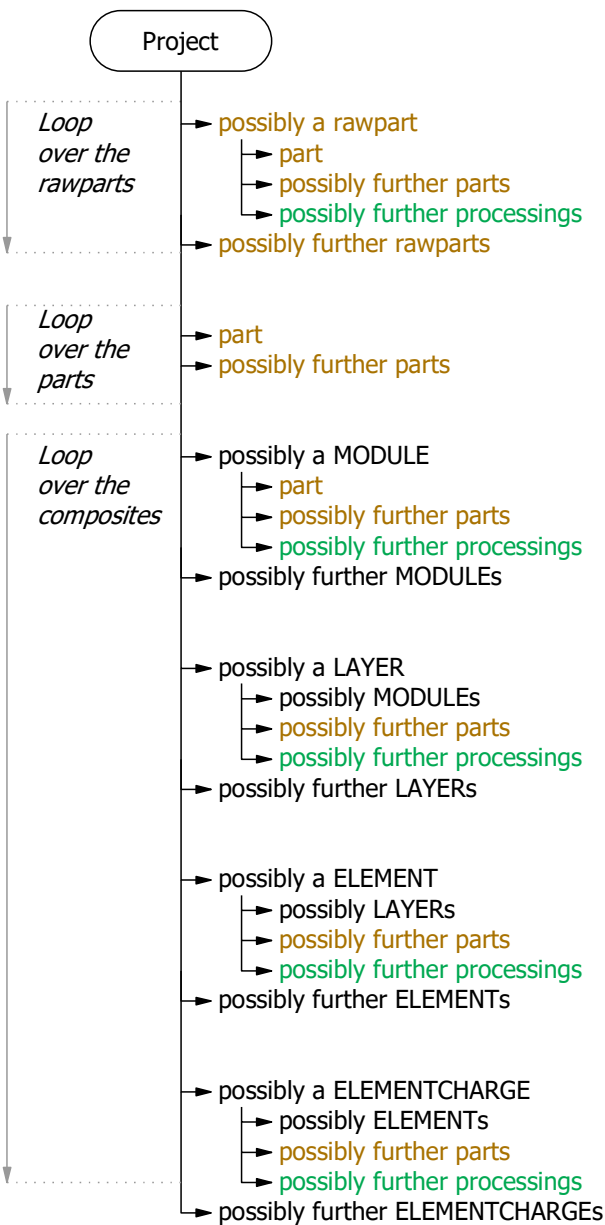

Hierarchical ordering

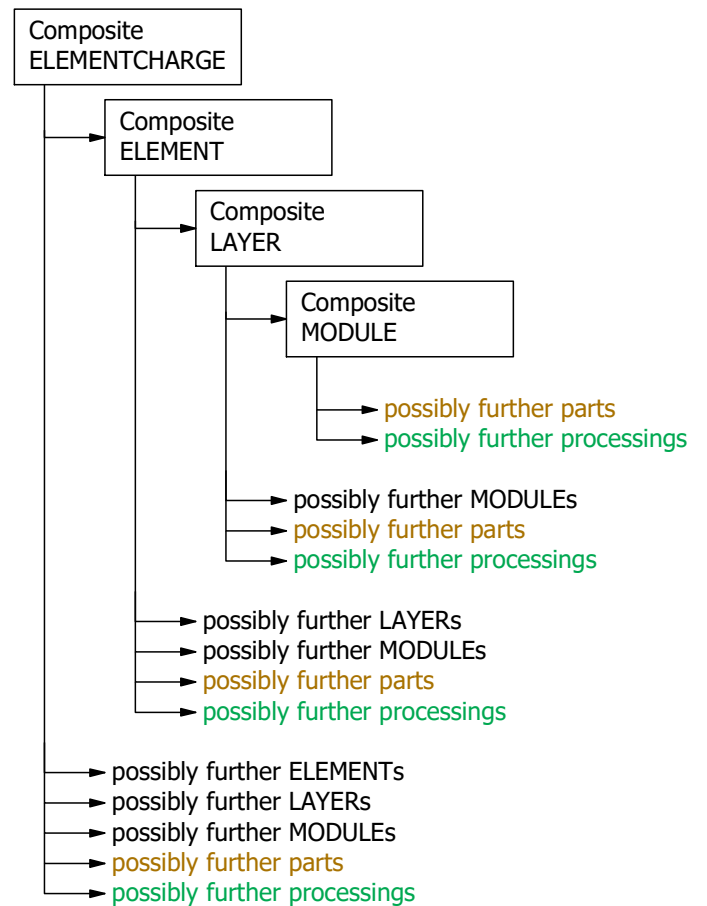

Example for a composite

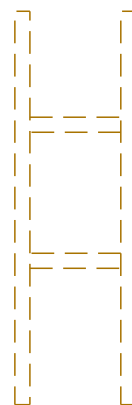
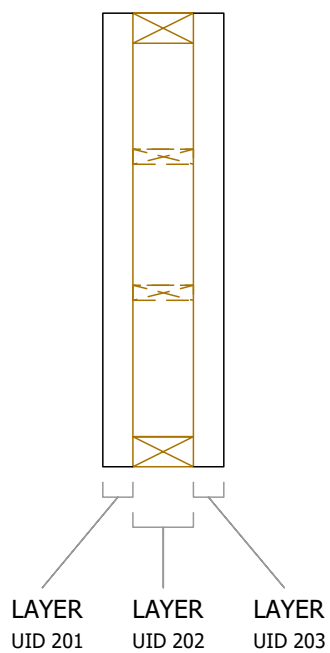
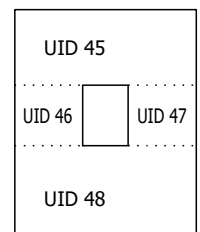
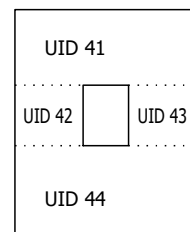
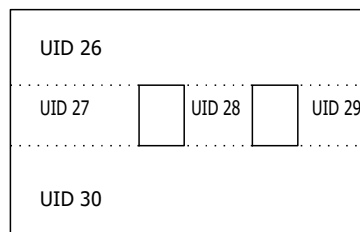
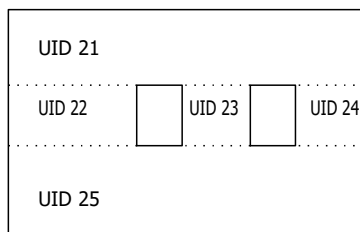
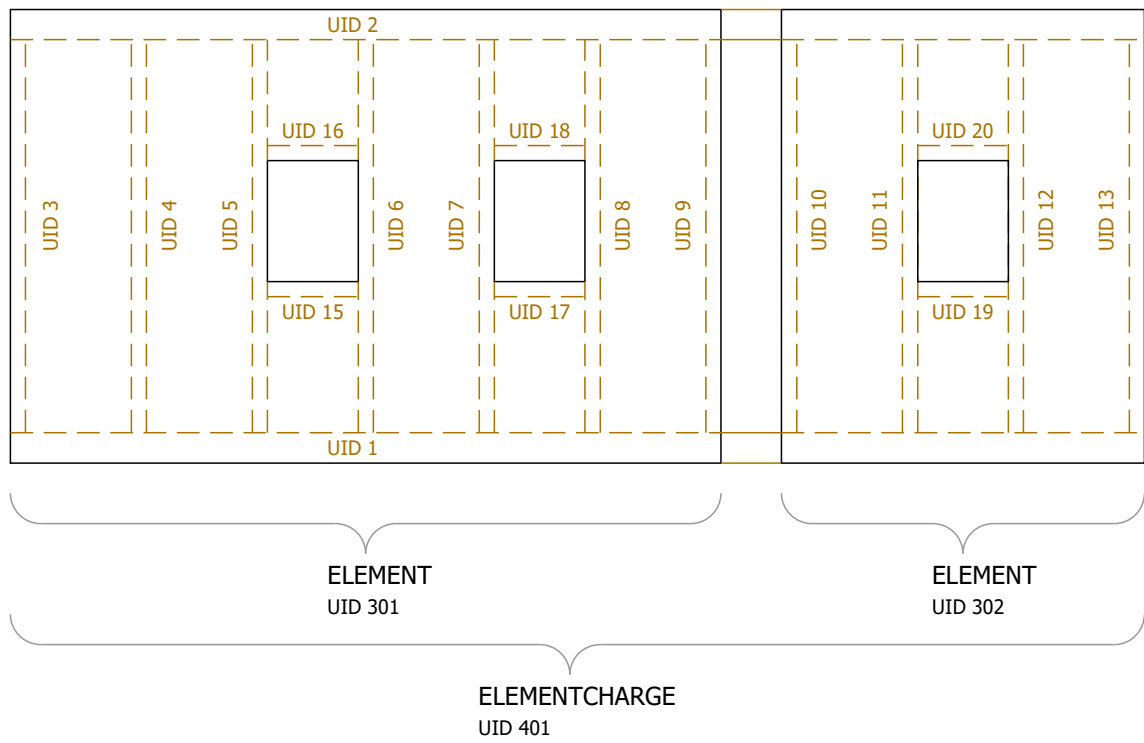

MODULE
UID 101
UID 102
UID 103

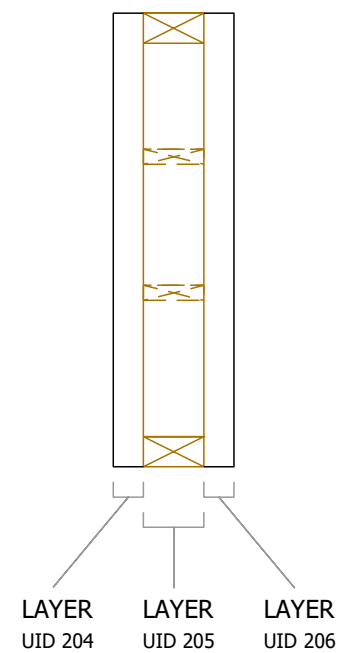

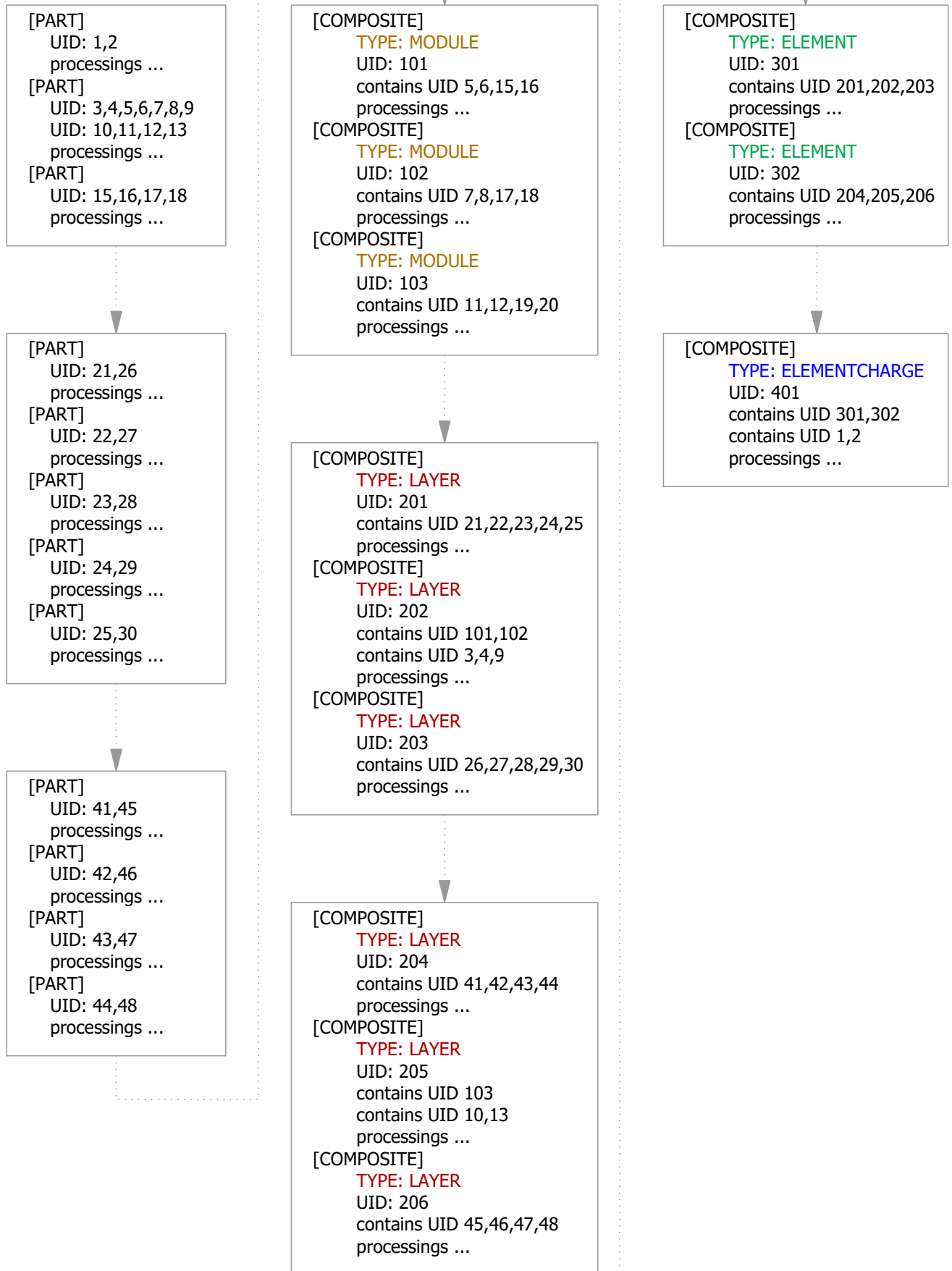

End of example for a composite